



2022 OWNER'S MANUAL

GEAR UP • CT

IMZ-URAL.COM

Intentionally left blank

INTRODUCTION

Welcome to the URAL Motorcycling Family! Your Ural has been built by the Irbit Motorcycle Factory in Russia and distributed by Irbit Motorworks of America, the United States affiliate of the Irbit Motorcycle Factory.

This Ural motorcycle conforms to all applicable US Federal Motor Vehicle Safety Standards and US Environmental Protection Agency regulations effective on the date of manufacture.

This manual covers the Gear-Up and cT model and has been prepared to acquaint you with the operation, care and maintenance of your motorcycle and to provide you with important safety information. Follow these instructions carefully for maximum motorcycle performance and for your personal motorcycling safety and pleasure. It is critical that a beginning sidecar driver becomes thoroughly familiar with the special operating characteristics of the sidecar outfit before venturing out on busy roads.

Your Owner's Manual contains instructions for operation, maintenance and minor repairs. Major repairs require the attention of a skilled mechanic and the use of special tools and equipment. Your Authorized IMWA Ural Dealer has the facilities, experience and genuine Ural parts necessary to properly render this valuable service.

Any suggestions or comments are welcome!

Happy Uraling!

IMPORTANT SAFETY INFORMATION

WE STRONGLY SUGGEST THAT YOU READ THIS MANUAL COMPLETELY PRIOR TO RIDING YOUR NEW URAL MOTORCYCLE. THIS MANUAL CONTAINS INFORMATION AND ADVICE THAT WILL HELP YOU PROPERLY OPERATE AND MAINTAIN YOUR MOTORCYCLE. PLEASE PAY SPECIAL ATTENTION TO NOTICES IN THIS MANUAL MARKED AS FOLLOWS:

CAUTION

INDICATES POSSIBILITY OF EQUIPMENT FAILURE THAT MAY RESULT IN YOUR MOTORCYCLE BEING UNSAFE TO OPERATE IF INSTRUCTIONS ARE NOT FOLLOWED

WARNING

INDICATES A VERY STRONG POSSIBILITY OF INJURY TO YOURSELF AND OTHERS OR LOSS OF LIFE IF INSTRUCTIONS ARE NOT FOLLOWED

NOTE

PROVIDES HELPFUL INFORMATION AND TIPS

Table of Contents

	Section
General Information	1
Motorcycle Controls and Instrumentation	2
Motorcycle Operation	3
Service & Maintenance Sections	
Lubrication	4
Engine & Chassis Maintenance	5
Electrical	6
EFI Troubleshooting	7
Consumer Information Sections	
Warranty Information	8
Emission Control Information	9
Owner Documents	10
Schematics	11

1. General Information

	Page
Service Rules	1-2
Model Identification	1-3
Model Specifications	1-4
Torque Chart	1-5
Clearance and Adjustment Specifications	1-6
Tire Data	1-6
Periodic Maintenance Chart	1-7
Motorcycle Storage and Care	1-8

SERVICE RULES

1. Always wear proper safety equipment including but not limited to safety glasses and gloves.
2. Allow your motorcycle to cool down completely prior to servicing to avoid getting burned.
3. Always use genuine Ural or Ural recommended parts, fluids and components when servicing your motorcycle. Parts that do not meet these requirements may result in damage.
4. Follow the service procedures as outlined in this manual.
5. Always follow the torque specifications when tightening nuts and bolts.
6. Clean all parts with non-flammable solvents prior to reassembly after servicing.
7. Always replace seals, O-rings, gaskets and cotter pins when reassembling.
8. If you remove self-locking nuts they should always be replaced with new ones.
9. Be responsible with solvents, cleaners and waste oils. Always dispose of them in accordance with your local regulations.

WARNING

IF THE ENGINE MUST BE RUNNING TO PERFORM A PARTICULAR SERVICE PROCEDURE BE SURE YOU ARE IN A WELL VENTILATED AREA. EXHAUST CONTAINS CARBON MONOXIDE GAS.

WARNING

GASOLINE IS VERY FLAMMABLE AND CAN BE EXPLOSIVE UNDER CERTAIN CONDITIONS. IT IS ALSO VERY HARMFUL TO THE SKIN AND EYES. DO NOT SMOKE OR ALLOW SPARKS IN OR NEAR YOUR WORK AREA.

MODEL IDENTIFICATION



VIN (Vehicle Identification Number)

The VIN label is located on the right hand frame down tube and is also stamped on the frame directly above the label.

List Your VIN Here

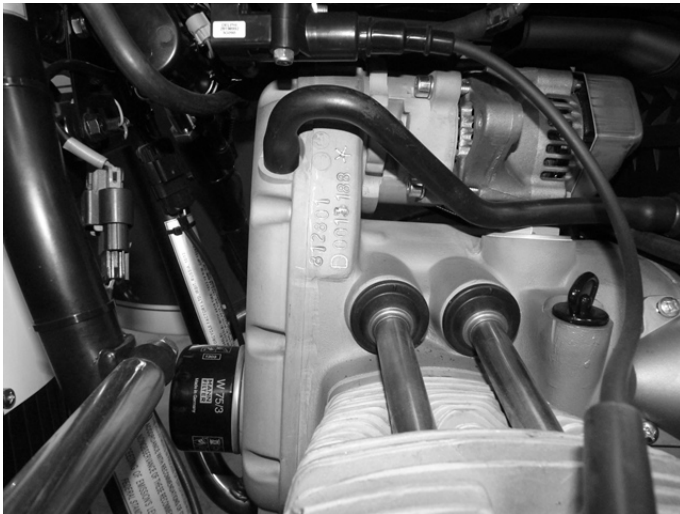

Engine Number

The engine number is stamped near the crankcase breather. It is the second number.

List Your Engine Number Here

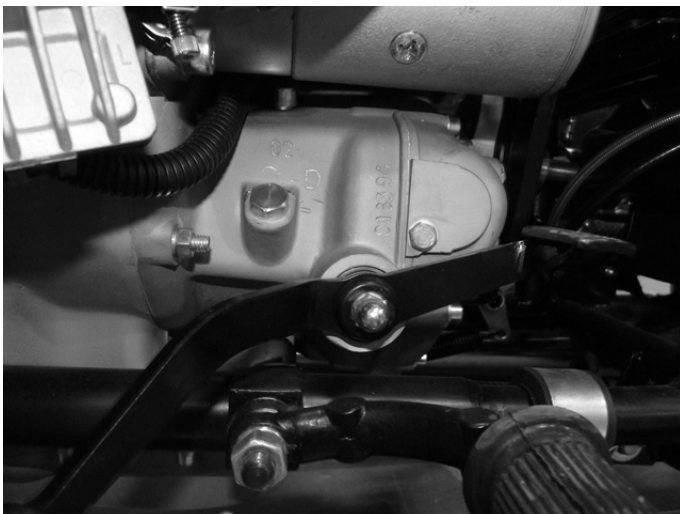

Gearbox Number

The gearbox number is stamped on the left side of the gearbox directly above the shift lever.

List Your Gearbox Number Here

MODEL SPECIFICATIONS

Model	cT	Gear-Up
Engine and transmission		
Displacement, cc	749	749
Engine type	OHV air cooled 2 cylinder 4 stroke "boxer" (flat twin)	OHV air cooled 2 cylinder 4 stroke "boxer" (flat twin)
Valve per cylinder	2	2
Bore and stroke (mm x mm)	78 x 78	78 x 78
Max output (hp)	41 @ 5500 rpm	41 @ 5500 rpm
Max torque (ft-lbs)	42 @ 4300 rpm	42 @ 4300 rpm
Compression	10.5:1	10.5:2
Fuel system	Throttle body EFI	Throttle body EFI
Starting	Electric & Kick start	Electric & Kick start
Clutch	Double-disc dry	Double-disc dry
Transmission type	Manual	Manual
Speeds	4 forward 1 reverse	4 forward 1 reverse
Primary drive (rear wheel)	Driveshaft	Driveshaft
Final drive ratio	4.62	4.62
Engagable sidecar wheel drive	No	Yes, driveshaft
Physical measures		
Overall length, inch.	91.6	98.8
Overall heights, inch.	53.8	54.3
Overall width, inch.	63.6	63.6
Seat height, (unladen), inch.	31.0	32.0
Ground clearance (unladen), inch.	7.2	7.5
Dry weight, lbs	700	730
Chassis		
Front suspension	IMZ leading link fork with two Sachs hydraulic spring shock absorbers, 7x adjustable	IMZ leading link fork with two Sachs hydraulic spring shock absorbers, 7x adjustable
Rear suspension	Double sided swing-arm with two Sachs hydraulic spring shock absorbers, 7x adjustable	Double sided swing-arm with two Sachs hydraulic spring shock absorbers, 7x adjustable
Sidecar suspension	Single sided swing-arm with Sachs hydraulic spring shock absorber, 7x adjustable	Single sided swing-arm with Sachs hydraulic spring shock absorber, 7x adjustable
Wheels	2.15X18 Aluminum rims with steel spokes	2.15X19 Aluminum rims with steel spokes
Tires	Heidenau K28, 4.0x18"	Heidenau K37, 4.0x19"
Front brake	4-piston fixed Brembo caliper with 295mm floating NG rotor	4-piston fixed Brembo caliper with 295mm floating NG rotor
Rear brake	2-piston fixed Brembo caliper with a 265mm floating NG rotor with a standalone mechanical parking brake caliper by J.Juan	2-piston fixed Brembo caliper with a 265mm floating NG rotor with a standalone mechanical parking brake caliper by J.Juan
Sidecar brake	2-piston fixed Brembo caliper with 245mm floating NG rotor	2-piston fixed Brembo caliper with 245mm floating NG rotor
Other		
Fuel grade	93 (AKI) 98 (RON) Unleaded Only	93 (AKI) 98 (RON) Unleaded Only
Fuel tank capacity (gallons)	5.0	5.0
Reserve (gallons)	app. 1	app. 1
Estimated fuel economy, mpg	31-37	31-37
Estimated range, miles	155-185	155-185
Recommended max cruising speed (mph)	70	70
Max permissible weight, lbs	1325	1325
Trunk volume, cubic ft.	2.9	2.9
Electrical		
Alternator	Denso, Peak Output 40 Amp @ 14vdc, 560 Wt	Denso, Peak Output 40 Amp @ 14vdc, 560 Wt
Battery	YTX20-BS (12V, 20A)	YTX20-BS (12V, 20A)
Headlight	H4 (60/55)	H4 (60/55)
Spark plugs	NGK BPR7HS-10	NGK BPR7HS-10
Warranty	2-years parts and labor unlimited mileage	2-years parts and labor unlimited mileage

TORQUE SPECIFICATIONS

Chassis	Newton Meters	Foot Pounds
Fork Pinch Bolts (Upper and Lower Bridges)	50	36.9
Upper fork Nuts	30	22.1
Steering Head Nut	34	25.1
Front fork Upper Shock Bolts	49	36.1
Upper Shock Bolts	30	22.1
Lower Shock Bolts	49	36.1
Front and Rear Brake Caliper Bracket Bolts	50	36.9
Rear Caliper Mounting Bolts	50	36.9
Front Caliper Mounting Bolts	50	36.9
Sidecar Caliper Mounting Bolts	50	36.9
Front Brake Reaction Link	70	51.6
Brake Rotors	30	22.1
Rear Swing Arm Mounting Bolts	88	64.9
Sidecar Swing Arm Mounting Bolts	88	64.9
Front Fork to Pivot of Swing Arm Mounting Bolts	50	36.9
Lower Sidecar Frame Mounting Bolts	88	64.9
Sidecar Strut Mounting Bolts	88	64.9
Spoke Nipple	4 to 6	2.9 to 4.4
Drive Train		
Engine, Gearbox, and Final Drive Drain Plugs	22	16.2
Cylinder Head Nuts	50	36.9
Valve Cover Bolts	12	8.8
Oil Pump Drive Gear Cap Bolt	10	7.4
Final Drive to Swing Arm Mounting Nuts	35	25.8
Final Drive Case Nuts	24	17.7
Engine Sump	10	7.4
Alternator Mounting Nuts	22	16.2
Intake Flange Mounting Bolts	20	14.8
Exhaust Header Pipe Nuts	24	17.7
Exhaust Mounting Clamp Bolts	16	11.8
Drive Wheel Splines (Spline Flanges)	30	22.1

CLEARANCES

Location	Millimeters	Inches
Intake Valves (Cold)	.1	.004
Exhaust Valves (Cold)	.1	.004
Spark Plug Electrode	1.00	0.04
Minimum Tread Depth	3.175	0.125
Minimum Brake Pad Thickness	1	0.04

FREE PLAY & ADJUSTMENTS

Location	Millimeters	Inches
Front Brake Lever	5 to 8	.2 to .3
Clutch Lever	5 to 8	.2 to .3
Rear Brake Lever	1/4 of Full Travel	1/4 of Full Travel
Toe-In (1wd)	8 to 12	.3 to .475
Toe-In (2wd)	3 to 8	.125 to .315
Lean Out	1 to 2 degrees	1 to 2 degrees

TIRE DATA

Location	Type	Recommended PSI
Front	Heidenau K38 (4.0x19) Heidenau K28 (4.0x18 cT)	32 PSI Cold
Rear	Heidenau K38 (4.0x19) Heidenau K28 (4.0x18 cT)	36 PSI Cold
Sidecar	Heidenau K38 (4.0x19) Heidenau K28 (4.0x18 cT)	32 PSI Cold
Spare (if equipped)	Heidenau K38 (4.0x19) Heidenau K28 (4.0x18 cT)	36 PSI Cold

WARNING

IMPROPER TIRE INFLATION WILL CAUSE ABNORMAL TREAD WEAR AND COULD RESULT IN UNSTABLE HANDLING. UNDER-INFLATION COULD RESULT IN THE TIRE SLIPPING ON THE RIM.

PERIODIC MAINTENANCE CHART

Description	Odometer reading, miles (km)							
	New	310 (500)	3125 (5000)	6250 (10000)	9375 (15000)	12500 (20000)	15625 (25000)	18750 (30000)
Check the painted and chromed surfaces for dents, scratches and rust	I			I		I		I
Engine oil*	I	R	R	R	R	R	R	R
Oil filter*		R	R	R	R	R	R	R
Final drive and gearbox oil	I	R	I	R	I	R	I	R
Check valve clearance		I	I	I	I	I	I	I
Check tightness of the cylinder stud nuts		I	I	I	I	I	I	I
Spark plugs		I	I	R	I	R	I	R
Fuel pump filter					R			R
Check torque for final drive fastening nuts		I	I	I	I	I	I	I
Air filter*		I	I	R	I	R	I	R
Check fuel hoses		I	I	I	I	I	I	I
Intake manifold gaskets (check for cracks and other damage)		I	I	R	I	R	I	R
Throttle body synchronization		I	I	I	I	I	I	I
Shock absorbers					I			I
Inspect wheels and tires (tire pressure, tire wear, rims breakage and dents, wheel balancing)*	I	I	I	I	I	I	I	I
Tightness of spokes		I	I	I	I	I	I	I
Tightness of fasteners	I	I	I	I	I	I	I	I
Disc brake (pads, disc, hoses, calipers and cylinders, lever travel)		I	I	I	I	I	I	I
Brake fluid level*		I	I	I	I	I	I	I/R
Check operations of parking brake	I	I	I	I	I	I	I	I
Front fork oil					R			R
Clutch, throttle cables and clutch lever travel	I	I	I	I	I	I	I	I
Bearings of the motorcycle and sidecar swing arms. 2wd linkage on 2wd models				I		I		I
Steering head bearings				I		I		I
Wheel bearings				I		I		I
Sidecar alignment	I				I			I
Battery (charge level, contacts) *		I	I	I	I	I	I	I
Electrical equipment	I	I	I	I	I	I	I	I
Headlight position	I	I	I	I	I	I	I	I
Lubrication of lever axels, cable ends, rear brakes cams, splined parts of the drive shafts and hubs, drive shaft U-joints*				I/L		I/L		I/L
Test drive	P	P	P	P	P	P	P	P
SERVICE LABOR	.8hrs	2hrs	1.8hrs	3.5hrs	2hrs	3.5hrs	1.8hrs	4.5hrs

I - Inspect, if necessary – adjust, clean or replace **R – Replace** * - Also repeat after 1 year in use and after long storage
L – Lubricate **P – Perform** ** - Also inspect when replacing tires

MOTORCYCLE STORAGE AND CARE

Storage

If you will be storing your motorcycle for the winter or long term, take the following steps:

1. The motorcycle should be cleaned.
2. Check all fluid levels and add as necessary.
3. Check tire pressure.
4. Lubricate all shafts, splines, cables and joints.
5. Use a battery maintenance charger or disconnect battery.
6. Always store in a warm dry place to avoid rust and moisture build up.
7. Use a protective cover when needed.

After storage take the following steps prior to running your motorcycle:

1. Perform the pre-ride inspection.
2. Reconnect battery and/or disconnect charger.
3. Follow starting procedures.
4. Take the motorcycle for a short ride prior to any long trips.

CLEANING

It is important to maintain your motorcycle properly and clean it on a regular basis. Use the following guidelines when washing your motorcycle:

- Make sure the engine is completely cool
- Use warm soapy water and wash thoroughly
- Avoid water entering the air filter and electrical components
- After washing, dry the motorcycle with a cloth
- Lubricate joints and cables as necessary
- Run motorcycle to evaporate remaining water

WINTER CONSIDERATIONS

Motorists in many areas of the US experience the use of salt and other chemicals that are applied to road surfaces in the winter. Salt and other caustic chemicals should always be washed off your bike with fresh water as soon as possible to avoid rust and corrosion.

NOTE

RUSTED OR CORRODED PARTS CAUSED BY SALT ARE NOT COVERED BY WARRANTY.

2. Motorcycle Controls & Instrumentation

	Page
Hand Controls	2-2
Foot Controls	2-3
Ignition Switch	2-4
Indicator Lamps	2-4
Speedometer Functions	2-5
Speedometer Operation	2-6
Parking Brake	2-7
Reverse Pedal	2-7
Kick Starter	2-8
2wd Engagement Lever	2-8
Hydraulic Spring Shock Absorbers	2-9
Hydraulic Steering Damper	2-9

HAND CONTROLS

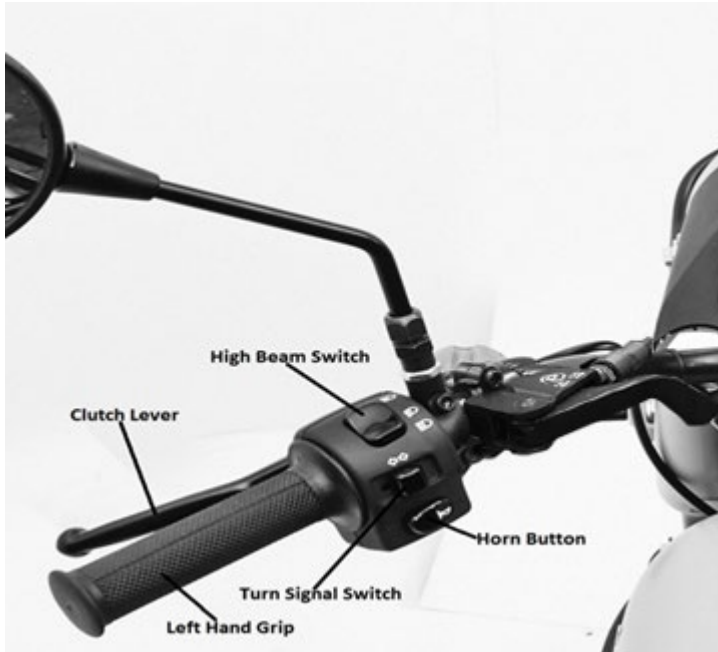

Clutch Lever

Pulling the clutch lever will disengage the clutch while releasing the lever will engage the clutch.

High Beam Switch

Toggle the switch forward to turn on the high beam and toggle back for "Flash to Pass" feature.

Horn Button

Press the button to sound the horn.

Turn Signal Switch

Switch left or right to indicate turns and push the button to cancel.

Left Hand Grip

Place your left hand on the grip to steer and control the motorcycle.

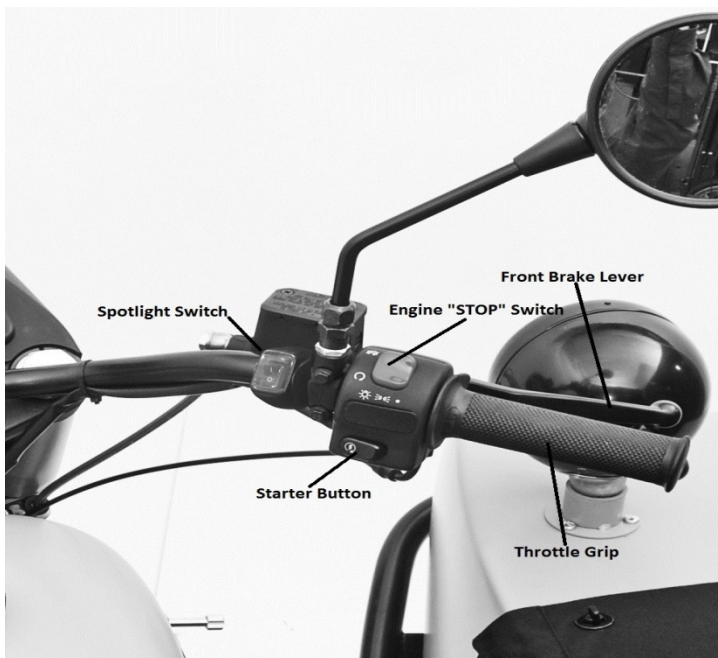

Front Brake Lever

Pulling the lever will actuate the front brakes.

WARNING

IF THE BRAKE LEVER FEELS SPONGY DO NOT RIDE THE BIKE AND CONTACT YOUR DEALER.

Starter Button

Press the button to engage the starter motor.

WARNING

WHEN USING THE STARTER ALWAYS BE SURE THE GEARBOX IS IN NEUTRAL.

Engine "STOP" Switch

Toggle the switch forward to stop the engine. Toggle back to run.

Throttle Grip

Place your right hand on the grip to steer and control the motorcycle. Rotate the grip back to open the throttle.

Spotlight/Fog Light Switch (If equipped)

Toggle the switch to control the sidecar spotlight/fog light.

FOOT CONTROLS



Shift Lever

This is a heel-toe type shifter. To upshift use the heel portion of the shift lever, to down shift use the toe portion of the shifter.

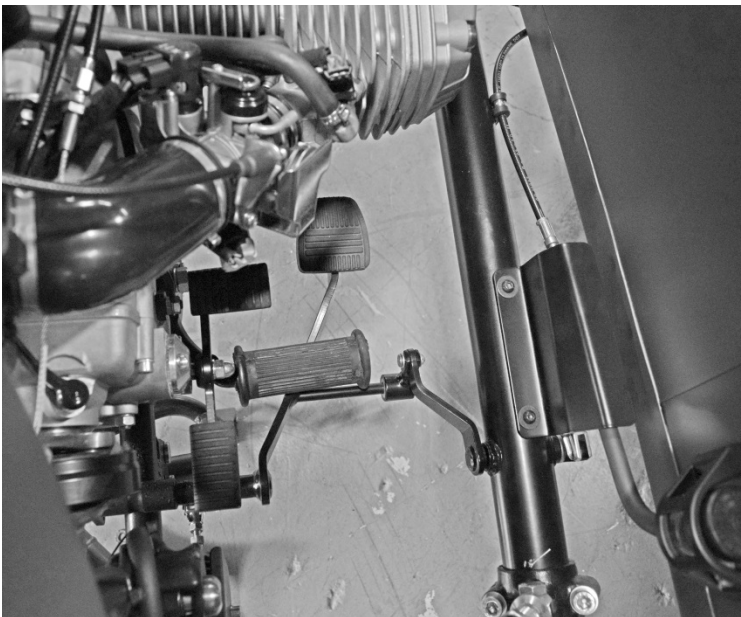

Rear Brake Lever

Pressing the rear brake lever actuates the rear and sidecar brakes.

WARNING

IF THE BRAKE LEVER FEELS SPONGY DO NOT RIDE THE BIKE AND CONTACT YOUR DEALER.

IGNITION SWITCH

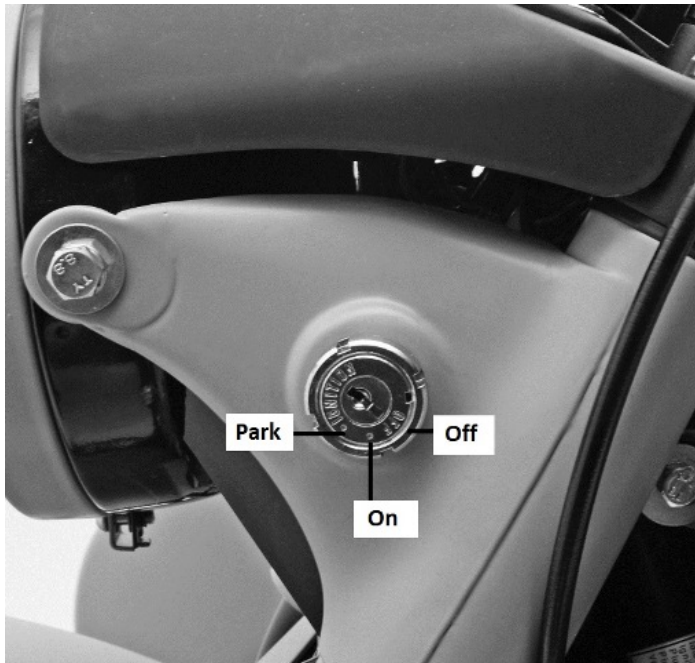

(3 Position Switch)

In the “Off” position the engine cannot be started.

In the “On” position the engine can be started and all electrical functions can be used.

In the “Park” position only the running lamps (not including headlight) are illuminated.

INDICATOR LAMPS



1. Engine “MIL” Indicator

If lamp illuminates while engine is running refer to “Troubleshooting” section of this manual.

2. High Beam Indicator

Lamp will illuminate when high beam is on.

3. Charging System Failure Indicator

Lamp will illuminate if the alternator fails.

4. Parking Brake Indicator

Lamp will illuminate when the parking brake is engaged.

5. Gearbox Neutral Indicator

Lamp will illuminate when gearbox is in neutral.

6. Turn Signal Indicator

Lamp flashes when signals are active.

7. Low Fuel Level Indicator

While on level ground lamp will flash when fuel level is low and become solid when on reserve level (approx. 1 Gal.)

NOTE

FUEL LAMP CAN GIVE FALSE INDICATION DUE TO SLOSHING WHILE RIDING. CHECK LAMP ON LEVEL GROUND.

SPEEDOMETER FUNCTIONS



Needle Speedometer:

Indicates speed by analogue needle.

RPM: Digital Tachometer

NOT ACTIVE

MAX RPM: Maximum Tachometer

NOT ACTIVE

SPD: Speedometer

Displays speed in MPH.

MAX SPD: Maximum Speed Meter

Displays highest speed achieved since last reset operation.

AVG: Average Speed Meter

Calculates average speed from last RESET.

TRIP 1 or 2: Trip Meter 1 or 2

TRIP function accumulates trip distance since last RESET as long as bike/vehicle is moving.

ODO: Odometer

ODO accumulates total distance traveled.

RT: Riding Timer

1. Calculates total running time since last RESET.

2. Counter automatically begins with movement.

TT: Total Riding Timer

1. Calculates total riding time from the beginning of the bike.

2. TT data is stored in memory and cannot be reset.

HRTT: Total Hour Meter

1. Calculates total engine operation time.

NOT ACTIVE

12/24 hour Clock:

Displays 12 or 24 hour current time.

Digital Voltage:

Indicates range 8-18VDC.

+TRIP: Maintenance Reminder

1. The maintenance reminder is set by trip meter and an "Off" mode to switch it off.

2. The trip meter maintenance can be set up to 9999.

SPEEDOMETER OPERATION



MODE Button

Press the MODE button to move from one function screen to another.

RESET Button

Press the reset button to cycle through functions in reverse order.

Data Resetting

1. Press MODE or RESET button to reach the desired screen then press RESET button for 2 seconds to reset TRIP 2, MAX SPD, MAX RPM and MAX TEMP data from stored values to zero individually. The maintenance reminder will be reset to the pre-set value.
2. The data of Trip 1, AVG & RT will all be reset at the same time when one of the 3 data functions are being reset.
3. ODO, clock, HRTT and TT data cannot be reset.

Data Programing

Press both MODE & RESET buttons to go into setting mode. In setting mode, pressing the RESET button increments the flashing digit by 1 position. Press MODE button to confirm the digit setting and jump to next digit or next setting screen to be set. Press MODE button for 2 seconds on any setting screen to finish and go to normal mode.

12/24 Hour Clock Set-up

Clock displays 12 or 24H in XX:XX:XX format and AM/PM when you select 12H option. Use MODE and RESET buttons as described above in **Data Programing** to finish clock setting and jump to the maintenance reminder setting or press MODE button for 2 seconds to finish and go to normal mode.

Maintenance Reminder Set-up

The maintenance reminder displays a picture of a wrench and is a separate TRIP meter. You can program the maintenance trip meter for the next scheduled service interval. Use MODE and RESET buttons as described above in **Data Programing** to finish maintenance reminder setting. Press MODE button for 2 seconds to finish and go to normal mode.

PARKING BRAKE



Parking Brake Lever

The parking brake lever is located on the left handle bar.

Pull the handle to the left lock position to set the parking brake.

Release the parking brake by pushing the lever to the right position as shown.

CAUTION

OPERATING THE MOTORCYCLE WHILE THE PARKING BRAKE IS ENGAGED CAN DAMAGE THE BRAKE SYSTEM.

REVERSE PEDAL



Reverse Engagement Pedal

The reverse pedal is located on the right side of the gearbox near the foot peg.

Push the pedal back with your heel while in Neutral to engage the reverse gear.

Push the pedal forward with your toe to put the gearbox back into Neutral and use forward gears.

CAUTION

THE REVERSE PEDAL MUST BE IN THE FULL FORWARD POSITION FOR THE GEARBOX TO SHIFT PROPERLY.

KICK START LEVER



Kick Start Lever

To use the kick start lever rapidly press the lever downward with your right foot as shown.

WARNING

WHEN USING THE KICK STARTER ALWAYS BE SURE THE GEARBOX IS IN NEUTRAL.

2WD ENGAGEMENT LEVER

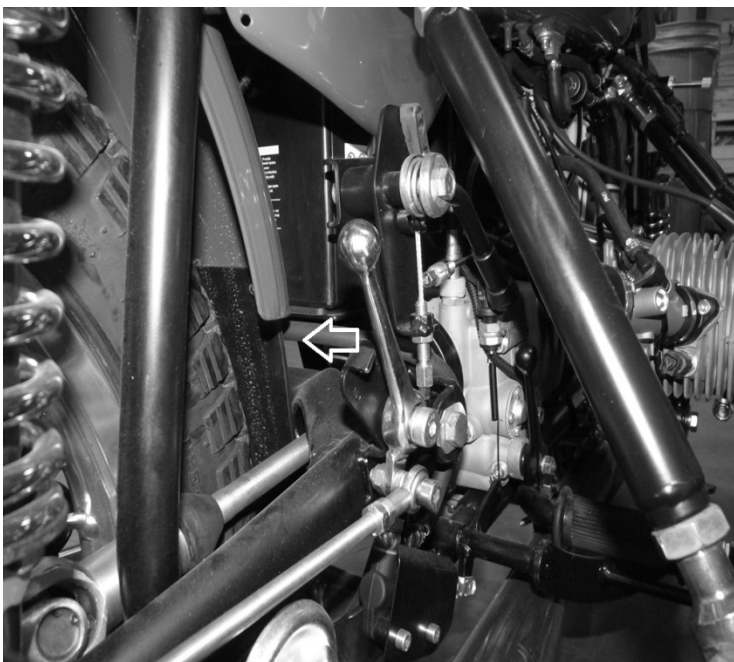

2wd Engagement Lever

Shift the lever into the rear locked position to engage 2wd.

Move the lever to the forward position to dis-engage 2wd.

CAUTION

2WD SHOULD ONLY BE USED FOR LOOSE ROAD CONDITIONS AND/OR OFF ROAD PURPOSES.

WARNING

USE OF 2WD ON THE STREET CAN MAKE THE MOTORCYCLE DIFFICULT TO STEER, POSSIBLY RESULTING IN LOSS OF CONTROL.

HYDRAULIC SPRING SHOCK ABSORBERS



Adjustable Shock Absorbers

The shock absorbers have 5 preload adjustments.

Rotate the adjustment ring counter clockwise as shown to increase spring preload using the supplied wrench in your tool kit.

HYDRAULIC STEERING DAMPER

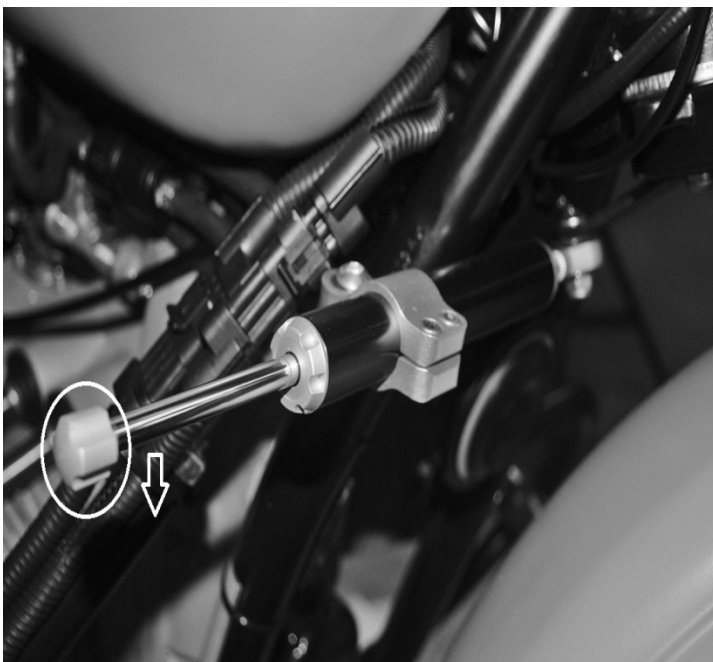

Adjustable Damper (16 Position)

The steering damper is fully adjustable to accommodate different riding styles and conditions.

Rotate the adjustment rod clockwise to increase dampening and counter clockwise to reduce dampening.

CAUTION

OVER ROTATION OF THE ADJUSTMENT ROD CAN DAMAGE THE DAMPER AND/OR CAUSE FLUID LEAKS.

3. Motorcycle Operation

	Page
Pre-ride Inspections	3-2
Initial Ride Instructions	3-2
Sidecar Safety	3-3
Starting Procedures	3-5
Run-In	3-6
Motorcycle Use and Loading	3-6

PRE-RIDE INSPECTIONS

Prior to each ride you should inspect the motorcycle's technical condition for safety. Use the following pre-ride inspection list to ensure your motorcycle is safe and ready to ride.

1. Check the oil level. Low oil level causes premature wear and possible engine damage.
2. Check the fuel level.
3. Check the tire pressure. Low tire pressure can cause poor handling. Also inspect the tire for abnormal and/or excessive wear that may lead to a flat tire.
4. Check all lights for proper operation including headlight, running lights, turn signals, and brake lights.
5. Check the brakes for proper operation and correct fluid level. If for any reason the brakes feel abnormal or spongy do not ride the bike as it may be unsafe.
6. Inspect all cables to insure they are not pinched or routed improperly; also inspect the clutch cable for correct free play.
7. Check for any loose fasteners and tighten as necessary.
8. Be sure any luggage is secured before riding.

INSTRUCTIONS FOR INITIAL RIDE

The following steps should be taken prior to and during your first ride:

1. Read the entire owner's manual prior to starting and/or taking you first ride.
2. Familiarize yourself with all controls and instruments.
3. Make any required adjustments to mirrors and controls for comfort.
4. Always wear safety gear including but not limited to: helmet, boots, gloves, and jacket regardless of weather.
5. Ride in a safe environment such as a parking lot or area you are familiar with while you learn the specific handling characteristics of your new sidecar motorcycle.
6. Follow the "Engine Run-in" instructions.

SIDECAR SAFETY

The Ural sidecar motorcycle, since it has three wheels, behaves quite differently from either a solo motorcycle or a car. For these reasons the following label has been attached to your motorcycle tank:

WARNING: LEFT-HAND AND RIGHT-HAND TURNS MAY BE DANGEROUS. EXCESSIVE SPEED AND AN UNWEIGHTED SIDECAR MUST BE AVOIDED.

Like any other motor vehicle, if the Ural is driven beyond its design limits, you can get hurt. Properly driven, since you have the added stability of the third wheel in case of sand, ice or slippery road conditions, the Ural will give you a much safer ride than a solo motorcycle in adverse conditions.

If possible, an experienced sidecar driver (preferably your Authorized Ural dealer) should ride along during your first ride. If not, put about 100 LB of ballast in the sidecar during your initial training. Although an experienced driver can safely drive the Ural with an empty sidecar, a beginner should always have ballast or a passenger in the chair.

Check with your local IMWA Dealer to find out your particular state's sidecar driver's license requirements.

When you accelerate, the Ural will pull slightly to the right due to the inertia and drag of the side car.

When you let off the gas it will pull slightly to the left due to the inertia of the sidecar.

Practice starting and stopping from various speeds, shifting up and down, accelerating and decelerating in each gear, turning right and left at slow-to-medium speeds.

WARNING

THE GEAR-UP WITH ENGAGEABLE SIDECAR WHEEL HANDLES DIFFERENTLY WITH THE SIDECAR DRIVESHAFT ENGAGED AND CANNOT TURN ON PAVED ROADS. FOR THIS REASON, THE SIDECAR DRIVE MUST ONLY BE ENGAGED WHEN OPERATING THE VEHICLE OFF-ROAD OR WHERE SNOW, ICE AND MUD CONDITIONS ARE ENCOUNTERED ON ROAD.

SIDECAR SAFETY (CONT.)

Finally, practice lifting the sidecar. To do this drive in a clockwise circle about 20 feet in diameter. Gradually increase your speed until the sidecar wheel lifts from the surface 6 - 12 inches. Then roll off the throttle and ease steering pressure on the grips so it gradually comes back down. Repeat doing this until you feel comfortable with the wheel in the air. Remember, the moment you roll off the throttle it will come down. When you have mastered “flying the chair” to the point where you can keep it in the air for a full circle you will have a good feel for the speed and turn radius that will lift the sidecar.

If, after gaining proficiency with the Ural, you plan to drive on the street with an empty sidecar, go back to the parking lot and practice the above maneuvers with an empty sidecar. You’ll find that the sidecar will lift much more readily when it is empty, especially if you enter a decreasing radius turn (such as a freeway off ramp) at too high a speed. This is why we recommend generally carrying about 100 lbs. or more in the sidecar.

WARNING

BALLAST WEIGHT SHOULD ALWAYS BE PROPERLY SECURED IN THE SIDECAR AND CENTERED FOR BEST BALANCE.

STARTING THE ENGINE WHEN COLD

Use the following instructions when starting a cold engine:

1. Check that you have enough fuel.
2. Switch ignition on.
3. Be sure the transmission is in neutral.
4. Switch the kill switch to run.
5. Press the starter button or use the kick starter until engine starts.
6. Allow engine to warm for a few moments prior to riding.

NOTE

ENGINE CRANKING SPEED CAN BE REDUCED IN COLD WEATHER, FOLLOW THE RECOMMENDATIONS FOR PROPER OIL WEIGHT FOUND ON PAGE 4-2.

CAUTION

DO NOT ACCELERATE WHILE STARTING THE BIKE! DO NOT RUN STARTER FOR MORE THAN 5 SECONDS. NEVER STAND IN FRONT OF THE MOTORCYCLE WHILE THE ENGINE IS RUNNING.

STARTING THE ENGINE WHEN WARM OR HOT

Use the following instructions when starting a warm or hot engine:

1. Check that you have enough fuel.
2. Switch ignition on.
3. Be sure the transmission is in neutral.
4. Switch the kill switch to run.
5. Press the starter button or use the kick starter until engine starts.

CAUTION

DO NOT ACCELERATE WHILE STARTING THE BIKE! DO NOT RUN STARTER FOR MORE THAN 5 SECONDS. NEVER STAND IN FRONT OF THE MOTORCYCLE WHILE THE ENGINE IS RUNNING.

ENGINE RUN-IN

During the first 600 miles it is important not to overload or over rev the engine while riding. To ensure proper break-in you should ride the motorcycle conservatively at varying speeds and loads. Use the following guidelines during the first 600 miles prior to the initial break-in service:

1. Do not overload or “lug” the engine.
2. Do not exceed a top speed beyond 60mph.
3. Do not ride at a constant rpm for long periods of time.
4. Try to vary speed and load when riding.
5. Shift smoothly between gears and do not down shift at high rpm.
6. Always be sure the engine is warmed up before riding.
7. Follow the pre-ride inspection.

MOTORCYCLE USE AND LOADING

Here are few things to consider for the best experience while planning and preparing your sidecar outfit for a trip. Remember, sidecars and their handling characteristics differ from their two wheeled counterparts.

Air cooled - Heat is detrimental to air cooled engines. When planning for a ride, consider a few factors before choosing your route.

- **What is the ambient temperature?**
- **Will I have a passenger or additional payload?**
- **What is the best route for the speed I will be able to maintain?**

External Temperature – Keep in mind how maintaining high rates of speed or carrying additional cargo can affect the temperature of the motor. Planning ahead while riding in warmer temperatures or with added payload will lessen the likelihood of encountering an unexpected change of plans.

High Speed – Urals are geared and tuned for off road use while providing the capability of long distance travel. The ability to do both restricts maximum speed. Maintaining max speeds all day can be taxing on the drivetrain. Plan ahead to arrive on time to your destination.

- **Rider, no passenger or payload: 65-70 mph.**
- **Rider and passenger, no payload: 60-65 mph.**
- **Rider, Passenger and payload up to max GVW 50-60 mph.**

Ural recommends a maximum speed of 70 mph. - The recommended max speed is not intended to be maintained for long periods of time. Reduce maintained max speed accordingly as temperatures rise throughout the day and/or if you will be traveling long distances with additional payload.

- **Reduce max speed for heavy payloads and as ambient temperatures rise.**
- **Allow the motor to cool at fill-ups. Take a break before resuming on a long trip.**
- **Give your Ural 20 minutes to cool for every 2 hours of use.**

Long Distance - Ural motorcycles are very capable of long distances if routine maintenance, rate of speed and the load are adjusted accordingly based on the conditions.

- **If traveling in warm temperatures, reduce speed and/or make periodic cooldown stops.**
- **Make it a habit on longer trips to check oil at fill-ups and cooldown/rest stops. High temperatures and sustained speed can lead to higher level of oil consumption.**

Off Road - Off road riding includes but is not limited to fire roads, desert trails, snow covered, obstructed, rutted, pot holed, rock covered paths, quarries, beaches, mud holes, etc. or any environment where speed, weight, traction, temperature extremes and other elements effect operation and/or navigation and the demands of the motorcycle beyond that of normal on highway use.

- **Do not ride beyond your skill level or the abilities of the motorcycle.**
- **Do not embark on unknown routes without proper resources to assist you in the event that an unforeseen circumstance does arise.**

If you choose to use your sidecar outfit in the manner outlined above, expect that maintenance and/or repairs **will be** required in addition to the regular service intervals.

Items often requiring inspection, service and/or repair after aggressive off road riding include but is not limited to:

- **Nuts, bolts, screws and other retaining fasteners that may have loosened or been lost due to vibration.**
- **Tires, tubes, spokes, wheel rims, shocks, steering damper, steering head bearings and swing arm pivot points.**
- **Clutch wear, cable stretch, brake pad wear, electrical connections and lighting.**

Load - The max permissible weight should be considered when planning a trip, choosing a route and while loading the outfit. Use common sense, particularly if you're planning to go off road.

- **Shock preload should be appropriate for the terrain and payload.**
- **Tire pressure should be in accordance with the specifications in the owner's manual.**
- **Clutch cable free play should be to specification to avoid excessive clutch slippage while navigating rough roads, loose sand or gravel, mud, etc.**
- **Being overloaded on the road and particularly over continuous rough terrain will deteriorate the sidecar bodies' rubber suspension faster than normal.**
- **When loaded and off road navigate obstacles slowly and cautiously, reduce speed over rough terrain.**

Recommend Max Additional Payloads

Gear-Up

590lb Max Additional Payload

M70/Retro

430lb Max Additional Payload

cT

440lb Max Additional Payload

Wind Drag & Load Equalization – Two elements often overlooked are wind drag and payload balancing.

Maximum cruising speeds should be reduced from the recommended maximum for sidecar outfits with windscreens that increase wind drag. This can create excessive heat leading to premature fatigue of vital components and possibly increase oil consumption.

Avoid “piling on” cargo in any location of the outfit that will act as a sail, increase wind drag and increase strain on the drive train. Unbalanced loads will change the handling characteristics in turns, while cornering and while braking. Optimize loading of cargo for better handling and safer operation.

Sidecar Loading Balance Percentage

Trunk area = 20%, Passenger Area = 70%, Front of Sidecar = 10%

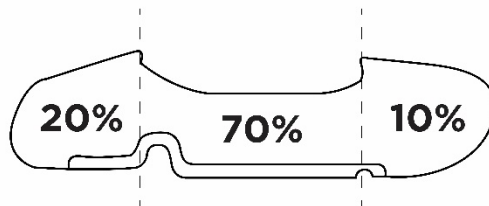

Accessory Location Do's and Don'ts – In addition to payload effects on handling and heat generating strain on the drivetrain, consider where accessories are to be mounted to maximize handling and safety.

- **Do mount factory authorized accessories with common sense in logical locations that avoid weakening substrates or anywhere that would jeopardize chassis integrity.**
- **Don't mount accessories in areas that will affect driver control, inhibit or limit steering function, pull throttle cables, limit brake pedal accessibility, etc.**
- **Don't mount Jerry cans or other hazardous items to the front area of the sidecar or anywhere an impact is more likely to create a safety hazard.**

Know Your Motorcycle – Be a conscientious rider and use your senses to alert you to potential changes in the performance of the drivetrain; sight, sound, smell, and feel.

- **Look at your dipstick, has oil consumption increased? The engine can use 16-26 milliliters of oil every 100 miles depending on riding conditions.**
- **Do you hear anything out of the ordinary? Are the brakes squeaking? A good running Ural has been compared to a sewing machine. If the pitch of the engine has changed or valve train is making excessive noise this could be a sign to take a break and let the engine cool. If the sound continues, further diagnosis will be required.**
- **Do you smell burnt oil, smoking clutch, rubber, gas? Any smell that stands out while riding or while stopped should be investigated to determine the source and assess the situation.**
- **Have you felt a loss of power, a shudder while stopping or maybe the brake lever feels different? Any changes that cannot be attributed to road conditions, wind, etc. should be investigated as soon as is safe to do so.**

Know your warranty - Know the limits of your warranty coverage as outlined in the owner's manual.

- **Purchase a road side assistance program in addition to or separate from your insurance to cover unexpected towing expenses should they arise.**
- **Are Ural dealers or service centers available along the chosen route? If not Ural shops are there repair facilities that can handle tire changes, oil changes, etc.**

For longer trips carry Ural specific spares for wear items not covered by warranty like, oil filters, brake pads, u-joints, etc.

4. Lubrication

	Page
Recommended Fluids, Lubricants & Capacities	4-2
Lubrication Diagram	4-3
Lubrication Points	4-4
Engine oil and filter replacement	4-5
Gearbox oil replacement	4-7
Final drive oil replacement	4-8
Drive Shaft Lubrication	4-9
Cable Lubrication	4-10

FLUIDS, LUBRICANTS & CAPACITIES

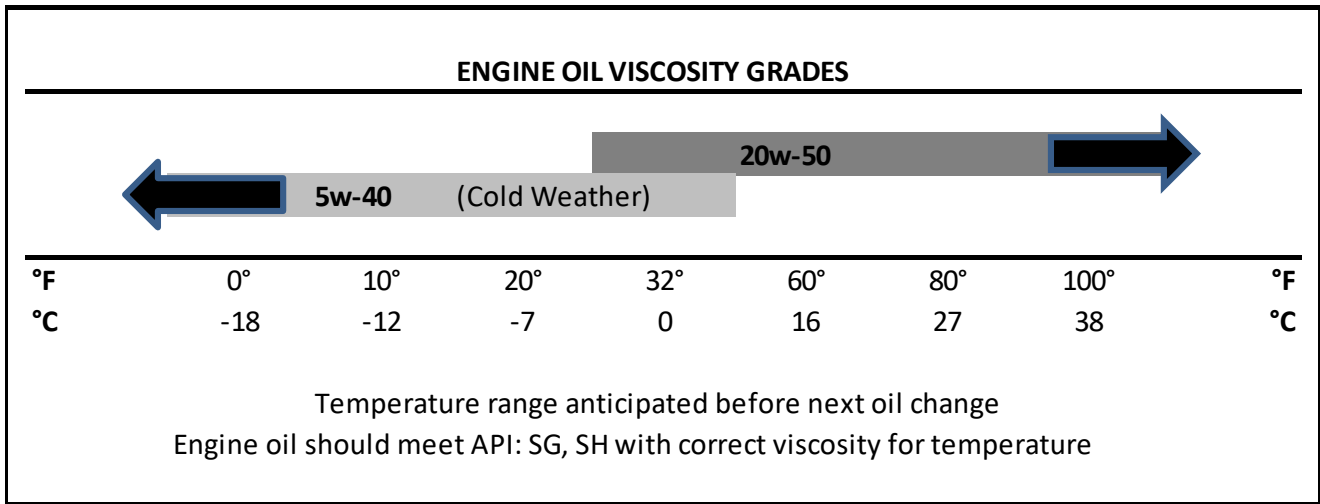

Location	Capacity	Type
Engine (with Filter Change)	2.6 l	Motul 3000 4T 20w50
Gearbox	0.9 l	Motul Twin SAE 75W90
Final Drive 2wd	115ml	Motul Twin SAE 75w90
Final Drive 1wd	90ml	Motul Twin SAE 75W90
Front Brake Reservoir	20 cm ³	Motul DOT 4
Rear Brake Reservoir	15 cm ³	Motul DOT 4
Sidecar Brake Reservoir	30 cm ³	Motul DOT 4
Drive Shaft Joints	N/A	Motul Tech Grease 300
Drive Shaft Spines	N/A	Motul Moly Grease
Clutch Shaft Splines	N/A	Motul Moly Grease
Drive Wheel Splines (Spline Flanges)	N/A	Motul Moly Grease
Wheel Axles	N/A	Motul Tech Grease 300
Brake Linkage and Pivots	N/A	Motul Tech Grease 300
Cables	N/A	Motul E.Z. Lube

NOTE

URAL MOTORCYCLES EXCLUSIVELY USES MOTUL FLUIDS AND LUBRICANTS DURING INITIAL ASSEMBLY. URAL MOTORCYCLES RECOMMENDS MOTUL FLUIDS AND LUBRICANTS FOR ALL SERVICE INTERVALS.

LUBRICATION DIAGRAM

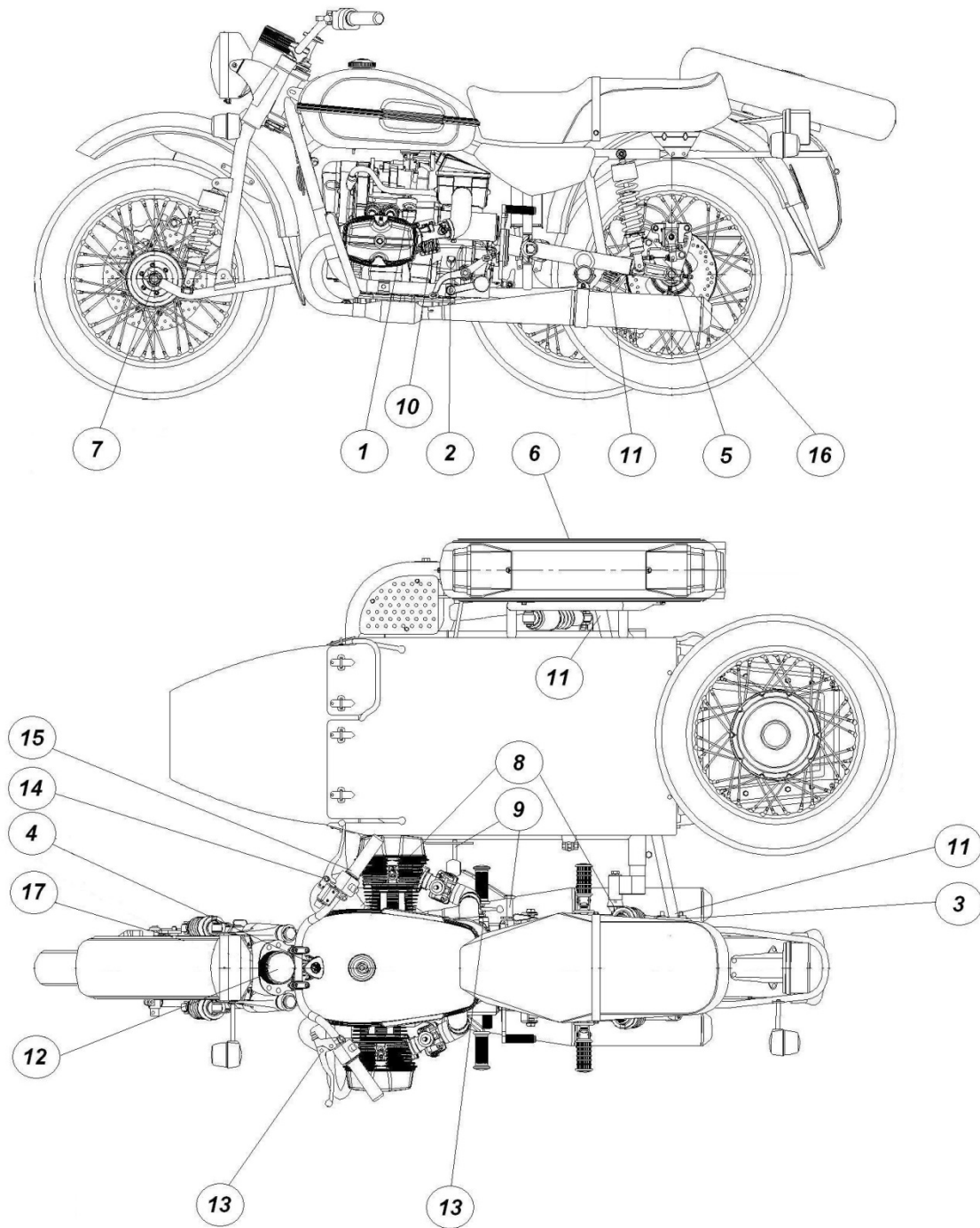

LUBRICATION POINTS

Diagram Position	Location	Type
1	Engine Oil Fill	Motul 3000 4T 20w50
2	Gearbox Oil Fill	Motul Twin SAE 75W90
3	Final Drive Oil Fill	Motul Twin SAE 75W90
4	Steering Head Bearing	Motul Tech Grease 300
5	Final Drive Output Spines	Motul Moly Grease
6	Sidecar Drive Shaft Splines (2wd)	Motul Moly Grease
7	Axles	Motul Tech Grease 300
8	Sidecar Mounting Pivots	Motul Tech Grease 300
9	Sidecar Brake Linkage Bushing	Motul Tech Grease 300
10	Clutch Shaft Splines	Motul Moly Grease
11	U-Joints	Motul Tech Grease 300
12	Speedometer Cable	Motul E.Z. Lube
13	Clutch Cable	Motul E.Z. Lube
14	Front Brake Lever Pivot Bolt	Motul Tech Grease 300
15	Throttle Cables	Motul E.Z. Lube
16	Parking Brake Cables	Motul E.Z. Lube
17	Front Brake Mount Axle Bushings	Motul Tech Grease 300

ENGINE OIL & FILTER REPLACEMENT



Step 1

Place a drain pan under the oil sump and remove the drain plug using a 17mm socket wrench.



Step 2

With the drain pan in place remove the oil filter.

NOTE

AN OIL FILTER WRENCH MAY BE REQUIRED FOR REMOVAL

CAUTION

BE SURE TO REMOVE THE OIL FILTER SEALING RING FROM THE ENGINE COVER TO AVOID OIL LEAKS

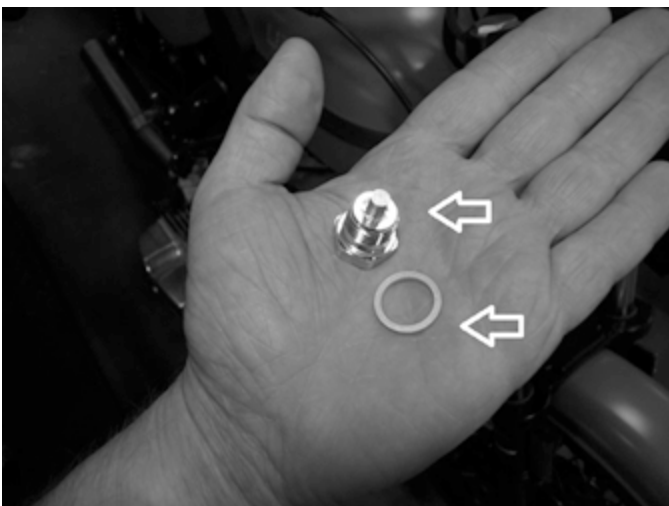

Step 3

Be sure to clean any metal contaminants from the drain plug and replace the drain plug sealing washer.

Step 4

Re-install drain plug and washer and torque to specification.

ENGINE OIL & FILTER REPLACEMENT (CONT.)



Step 5

Lightly lubricate the new oil filter sealing ring with fresh oil and install filter tightening approximately $\frac{1}{4}$ turn after seat of seal.

CAUTION

DO NOT OVER-TIGHTEN THE OIL FILTER



Step 6

Fill engine with 2.6L of recommended motor oil

Step 7

Start the engine and let run for 30 seconds, confirming you have no oil leaks at filter.

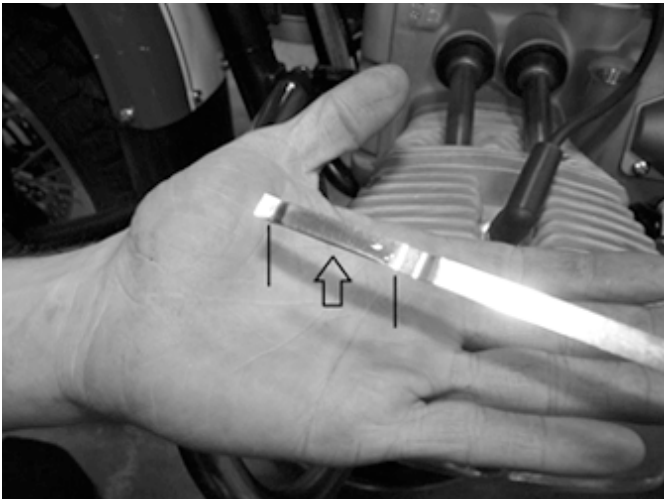

Step 8

Check oil level, oil should be full to the upper mark on the dipstick, add oil as needed.

NOTE

ALWAYS DISPOSE OF MOTOR OIL PROPERLY

GEARBOX OIL REPLACEMENT



Step 1

Place a drain pan under the gearbox and remove drain plug using a 17mm socket wrench.

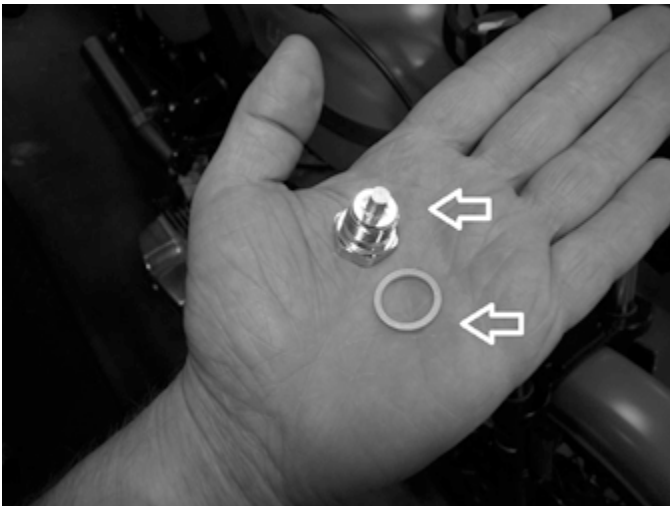

Step 2

Be sure to clean any metal contaminants from the drain plug and replace the drain plug sealing washer.

Step 3

Re-install drain plug and washer and torque to specification.

Step 4

Fill the gearbox with .9L of recommended gear oil.



Step 5

Re-install fill plug and torque to specification.

NOTE

ALWAYS DISPOSE OF MOTOR OIL PROPERLY

FINAL DRIVE OIL REPLACEMENT

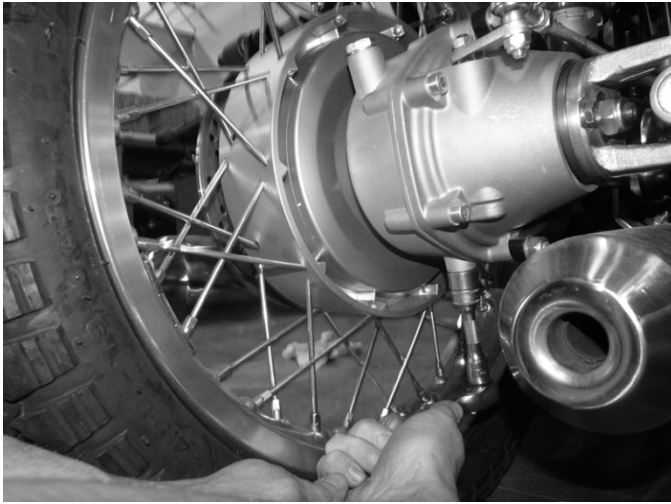

Step 1

Place a drain pan under the final drive and remove the drain plug using a 17mm socket wrench.

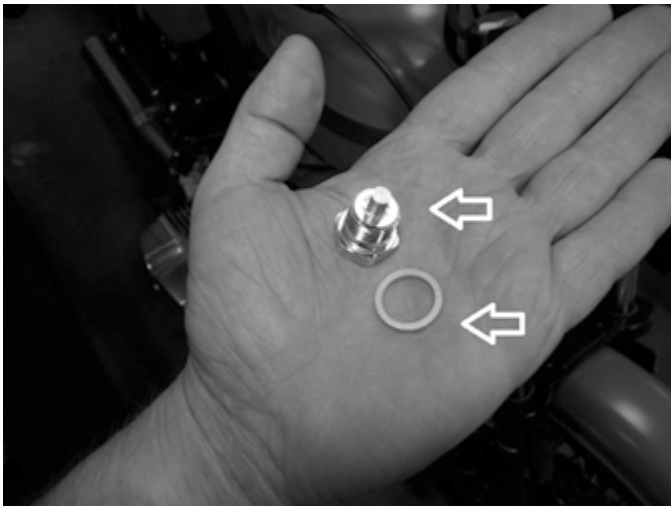

Step 2

Be sure to clean any metal contaminants from the drain plug and replace the drain plug sealing washer.

Step 3

Re-install drain plug and washer and torque to specification.

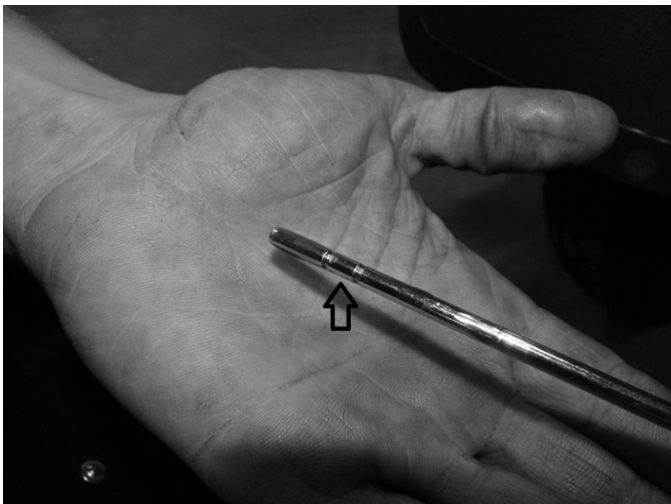

Step 4

Fill the final drive with 115ml (2wd) or 90ml (1wd) of recommend gear oil.

Step 6

Check oil level by threading the dipstick into the case. Oil should be full to the upper mark. Add fluid as needed.

NOTE

ALWAYS DISPOSE OF GEAR OIL PROPERLY

DRIVE SHAFT & SPLINE LUBRICATION



Final Drive Shaft

U-Joints should be lubricated with grease using a grease gun.

The rear drive shaft has one grease zerk located at the u-joint; grease this joint per the maintenance intervals or after off road use.

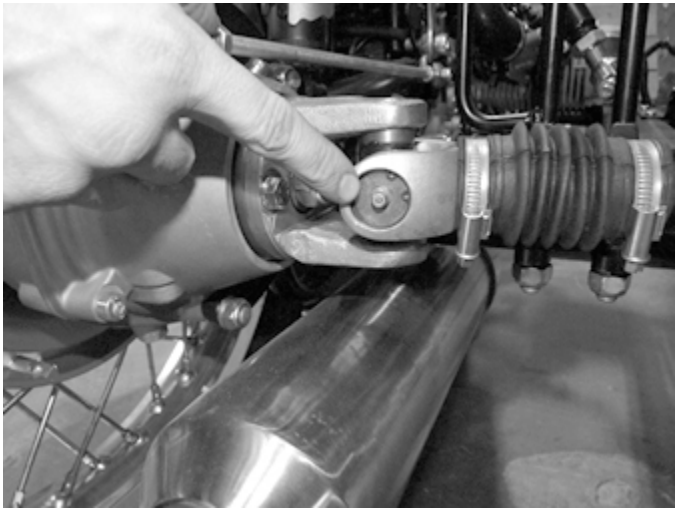

Sidecar Drive Shaft

On 2wd models only the sidecar drive shaft has two grease zerks located at each u-joint; grease these joints per the maintenance intervals or after off road use.

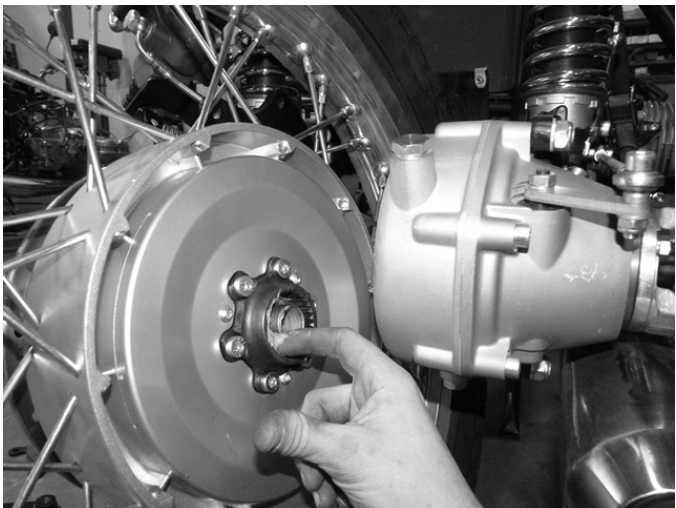

Drive Wheel Splines

The rear wheel drive splines should be greased per the maintenance intervals or after off road use.

2wd models also have drive splines located on the sidecar wheel; splines should be greased per the maintenance intervals or after off road use.

CABLE LUBRICATION



All cables including the clutch, speedometer, throttle, and parking brake cables should be lubricated with Motul E.Z. Lube per the maintenance intervals. You should also lubricate all cables before and after extended periods of storage and/or after off road use.

To lubricate the cables, pull back the protective covers and apply lube directly to the cable as shown. You can also use cable lubrication tools available by aftermarket companies.

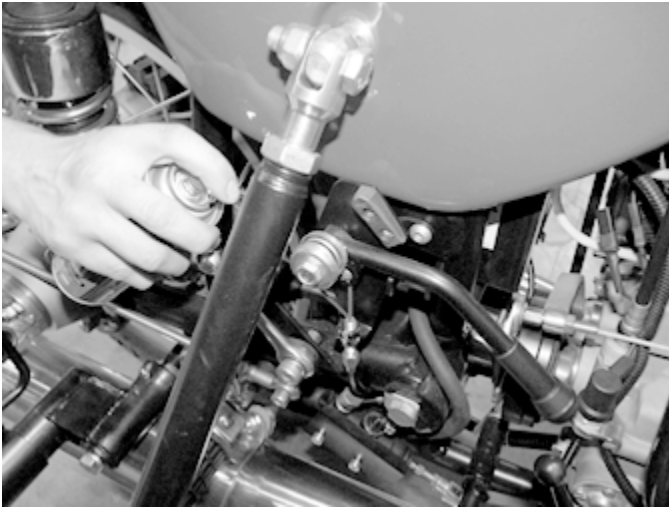

5. Engine & Chassis Maintenance

	Page
Air filter Inspection & Replacement	5-2
Valve Train Inspection & Adjustment	5-3
Front Brake System Maintenance	5-5
Rear Brake System Maintenance	5-7
Parking Brake Adjustment	5-9
Sidecar Brake System Maintenance	5-10
Wheel Removal & Installation	5-12
Using the Spare Wheel	5-20
Spoke Maintenance	5-20
Wheel Bearing Replacement & Diagrams	5-21
Tire & Tube Replacement	5-22
Sidecar Alignment	5-23
Sidecar Alignment Diagram	5-24

AIR FILTER INSPECTION & REPLACEMENT



Step 1

Remove the four retaining bolts from the air box lid using a 5mm hex wrench.



Step 2

Carefully remove the air box lid by lifting the right side and sliding the lid to the left. Be very careful not to pull wiring and cables near the air box inlet.

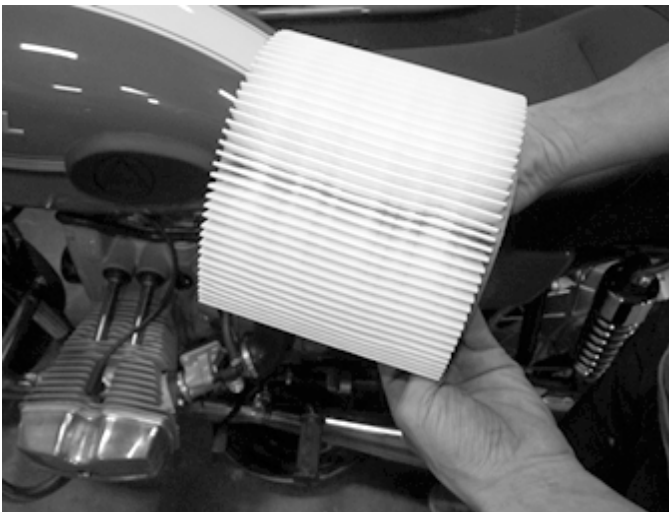

Step 3

Remove the paper filter element from the housing and inspect for debris. The filter should be replaced per the maintenance intervals and/or as need during inspections.

Step 4

Re-install the filter in reverse order. Be sure the replacement filter is fully seated in the air box housing and the lid is properly installed prior to tightening the retaining bolts.

CAUTION

A DIRTY OR CLOGGED AIR FILTER CAN REDUCE THE PERFORMANCE OF YOUR ENGINE AND POSSIBLY DAMAGE INTERNAL ENGINE PARTS.

VALVE TRAIN INSPECTION & ADJUSTMENT



Step 1

Starting with the left side cylinder, remove the valve cover and clean any contaminants found inside with a shop towel.



Step 2

Remove the timing plug located on the right side of the engine case. Slowly rotate the engine using the kick start lever until both valves are closed and the TDC (top dead center) mark located on the flywheel is centered in the window.



Step 3

Using a feeler gauge, check the free play on both valves to confirm they are within specifications.

VALVE TRAIN INSPECTION & ADJUSTMENT (CONT.)



Step 4

If the free play clearance is not within specifications adjust as necessary. First loosen the jam nut and turn the adjustment bolt.

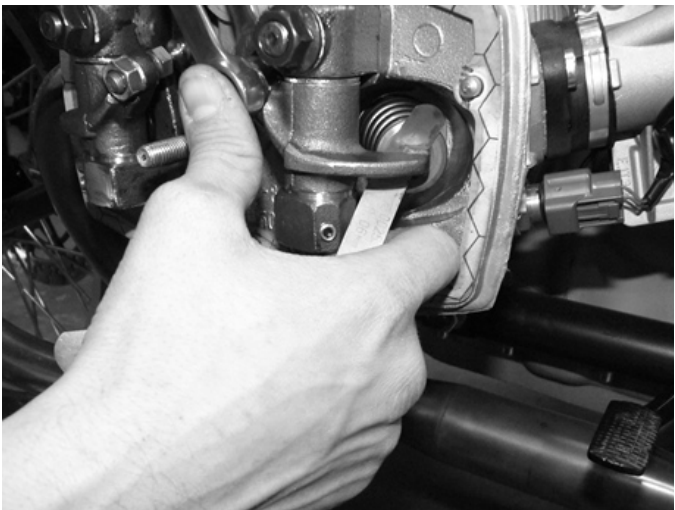

Step 5

After adjustment reconfirm the clearance is within specifications.

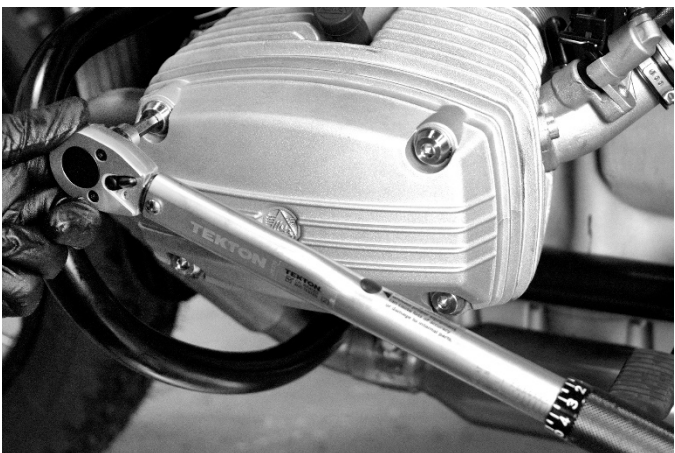

Step 6

Replace the valve cover gasket, bolt seals and re-torque the valve cover bolts.

Step 7

Repeat the process on the right side by rotating the engine with the kick starter 360 degrees. Again, both valves will be closed and the TDC mark should be centered in the window.

CAUTION

OPERATING THE ENGINE WITH IMPROPERLY ADJUSTED VALVES CAN LEAD TO POOR PERFORMANCE AND POSSIBLE ENGINE DAMAGE.

FRONT BRAKE SYSTEM MAINTENANCE



Step 1

Remove the retaining pin safety clips.

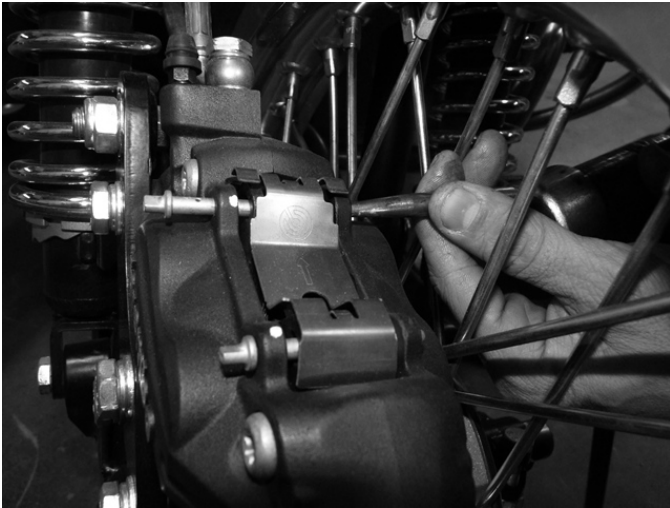

Step 2

Carefully drive the retaining pins out of the caliper using a small punch or drift.

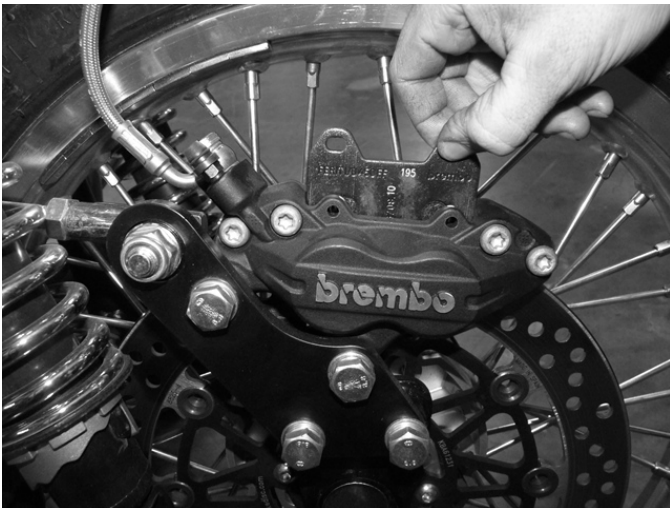

Step 3

Remove the brake pads by pulling them out the top of the caliper.

FRONT BRAKE SYSTEM MAINTENANCE (CONT.)



Step 4

Inspect the brake pads and replace as needed.

NOTE

MINIMUM PAD THICKNESS IS 1MM

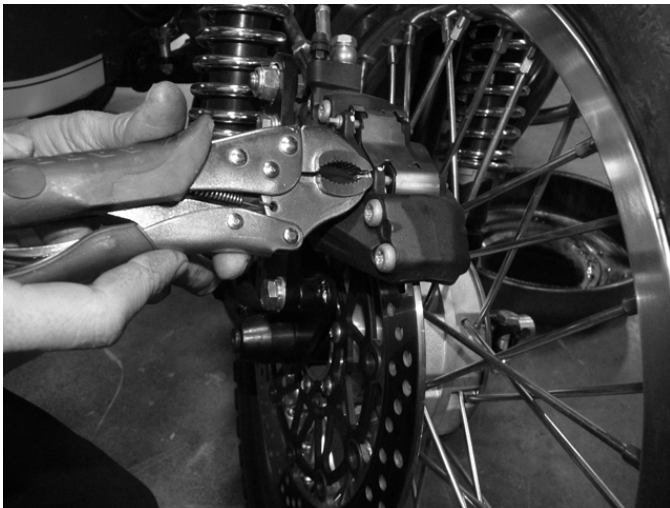

Step 5

Re-install brake pads in reverse order.

Be sure to fully seat the retaining pins and install the safety clips.

Step 6

Confirm the brake fluid level is full in the reservoir and add as needed to FULL line.

DO NOTE OVER FILL

CAUTION

OPERATING THE MOTORCYCLE WITH WORN BRAKE PADS CAN CAUSE DAMAGE TO THE BRAKE ROTORS.

WARNING

OPERATING THE MOTORCYCLE WITH WORN BRAKE PADS BELOW THE MINIMUM THICKNESS CAN RESULT IN POOR BRAKING AND POSSIBLE ACCIDENT.

WARNING

OPERATING THE MOTORCYCLE WITH LOW FLUID LEVEL CAN CAUSE LOSS OF BRAKING FORCE.



REAR BRAKE SYSTEM MAINTENANCE



Step 1

Place the bike on the center stand. Remove lower shock mounting bolt and swing the shock back to access brake caliper.



Step 2

Remove the caliper mounting bolts and remove the caliper.



Step 3

Remove the caliper safety clip and carefully remove the retaining pin out of the caliper. A punch or drift may be used.

REAR BRAKE SYSTEM MAINTENANCE (CONT.)



Step 4

Remove and inspect the brake pad, replace as needed.

NOTE

MINIMUM PAD THICKNESS IS 1MM



Step 5

Re-install brake pads in reverse order. DO NOT forget to install the safety clip.

Step 6

Confirm the brake fluid level is full in the reservoir and add as needed to FULL line.

DO NOT OVER FILL

CAUTION

OPERATING THE MOTORCYCLE WITH WORN BRAKE PADS CAN CAUSE DAMAGE TO THE BRAKE ROTORS.

WARNING

OPERATING THE MOTORCYCLE WITH WORN BRAKE PADS BELOW THE MINIMUM THICKNESS CAN RESULT IN POOR BRAKING AND POSSIBLE ACCIDENT.

WARNING

OPERATING THE MOTORCYCLE WITH LOW FLUID LEVEL CAN CAUSE LOSS OF BRAKING FORCE.

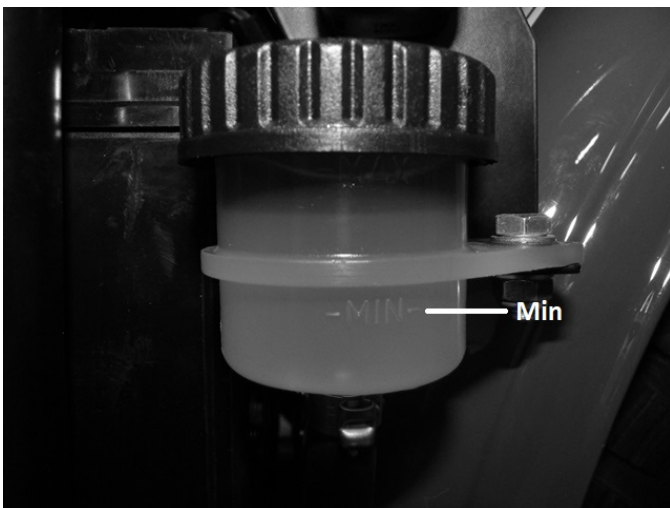

PARKING BRAKE ADJUSTMENT



Step 1

Locate the cable adjuster connected to the parking brake handle and be sure the parking brake is in the “off” position.



Step 2

Adjust the cable to remove excess free play by tightening lower adjustment nut.



NOTE

ADJUST CABLE FOR MINIMAL FREEPLAY WITHOUT DRAG. ROTATE WHEEL AND INSPECT FOR FREE ROTATION.

SIDECAR BRAKE SYSTEM MAINTENANCE



Step 1

Remove the caliper mounting bolts.



Step 2

Remove the caliper from the sidecar swing arm.

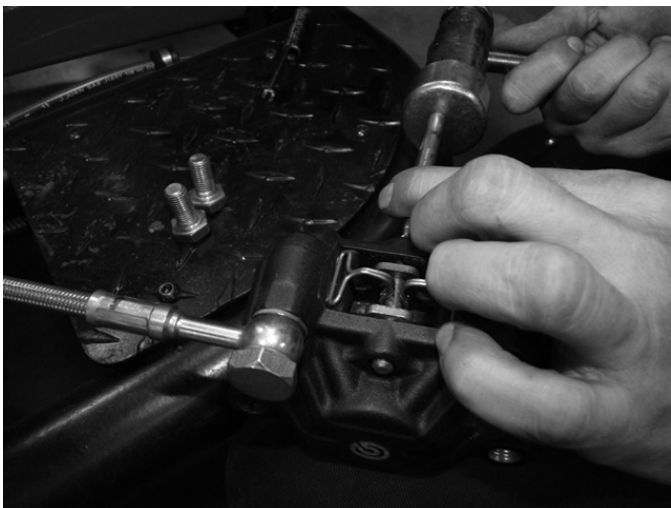

Step 3

Remove the caliper safety clip and carefully drive the retaining pin out of the caliper with a punch or drift.

SIDECAR BRAKE SYSTEM MAINTENANCE (CONT.)



Step 4

Remove the brake pads by pulling them out of the bottom of the caliper.



Step 5

Inspect the brake pads and replace as needed.

NOTE

MINIMUM PAD THICKNESS IS 1MM

Step 6

Re-install the brake pads and caliper in reverse order. **DO NOT** forget to install the safety clip.

Step 7

Confirm the brake fluid level is full in the reservoir and add as needed to FULL line.

DO NOT OVER FILL

CAUTION

OPERATING THE MOTORCYCLE WITH WORN BRAKE PADS CAN CAUSE DAMAGE TO THE BRAKE ROTORS.

WARNING

OPERATING THE MOTORCYCLE WITH WORN BRAKE PADS BELOW THE MINIMUM THICKNESS CAN RESULT IN POOR BRAKING AND POSSIBLE ACCIDENT.

WARNING

OPERATING THE MOTORCYCLE WITH LOW FLUID LEVEL CAN CAUSE LOSS OF BRAKING FORCE.



FRONT WHEEL REMOVAL & INSTALLATION



Step 1

Remove the lower caliper mounting bracket bolts.



Step 2

Carefully support the brake caliper using a strap.

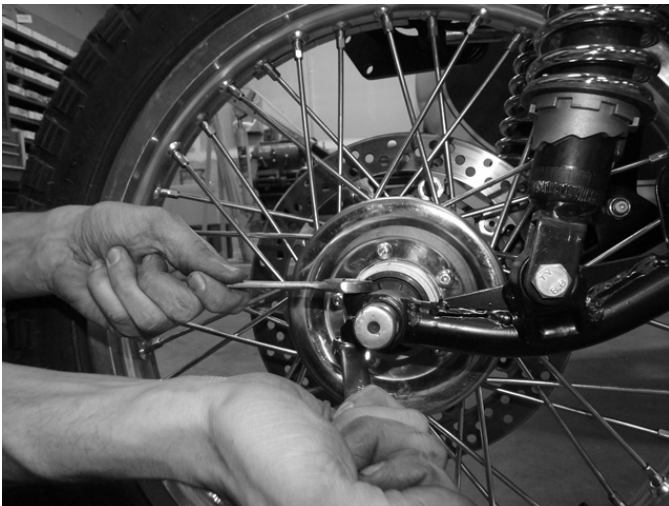

Step 3

Loosen the axle pinch bolt.

FRONT WHEEL REMOVAL & INSTALLATION (CONT.)



Step 4

Loosen the axle by rotating clockwise and remove from the wheel.



Step 5

To re-install the wheel first place the caliper mount into the wheel.



Step 6

Position the wheel back on the bike and install the axle. DO NOT tighten fully at this point.

FRONT WHEEL REMOVAL & INSTALLATION (CONT.)



Step 7

Re-attach the caliper with mounting brackets and tighten to specification.



Step 8

Tighten the axle by rotating counter-clockwise.



Step 9

Tighten the axle pinch bolts to specification.

REAR WHEEL REMOVAL & INSTALLATION



Step 1

Place the motorcycle on the center stand.

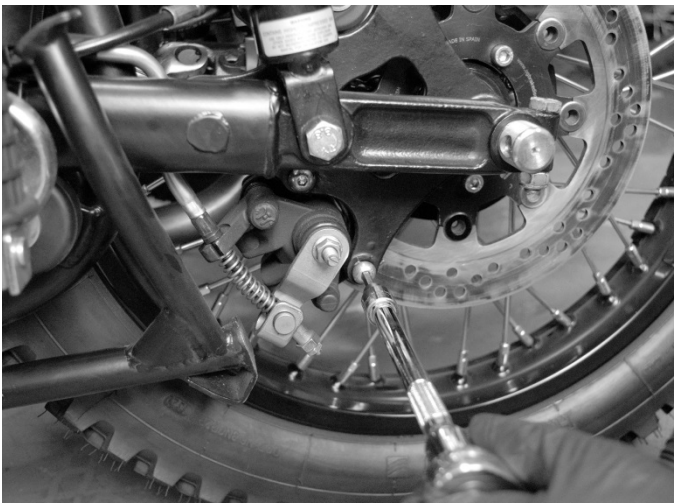

Step 2

Remove the parking brake caliper using a 5mm hex key wrench.

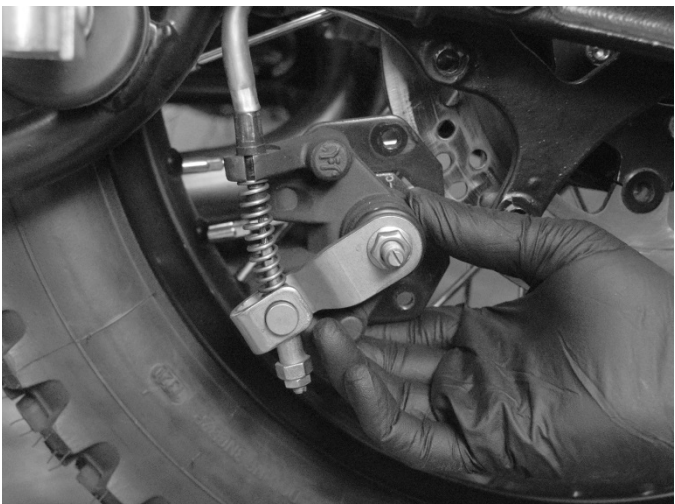

Step 3

Allow the parking brake caliper to drop down and out of the way.

REAR WHEEL REMOVAL & INSTALLATION (CONT.)

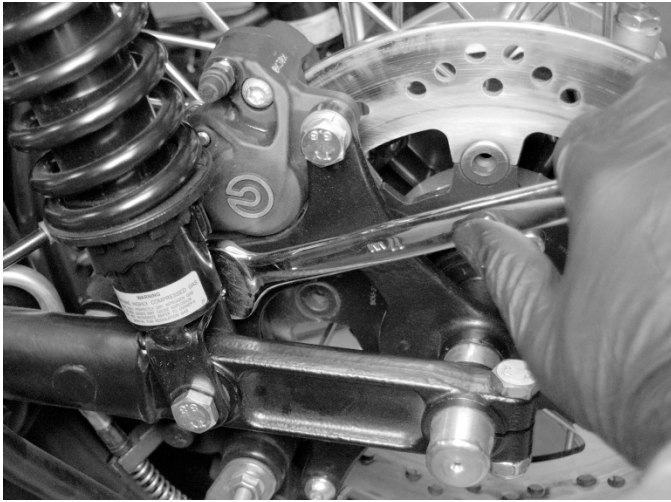

Step 4

Loosen both brake caliper mounting bolts using a 17mm wrench.

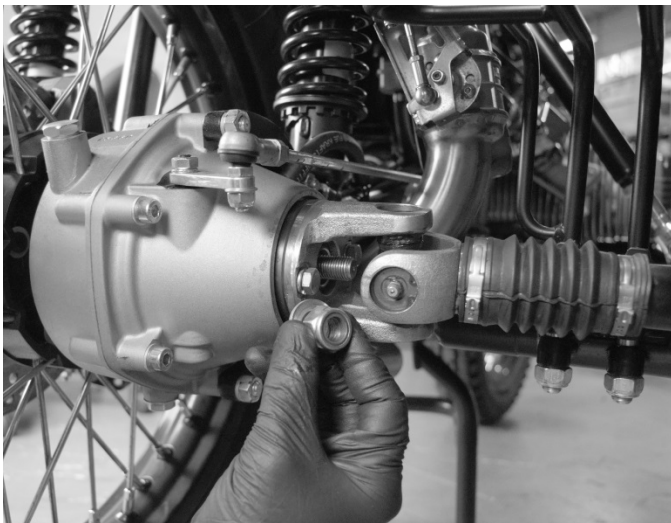

Step 5

Remove the axle nut.

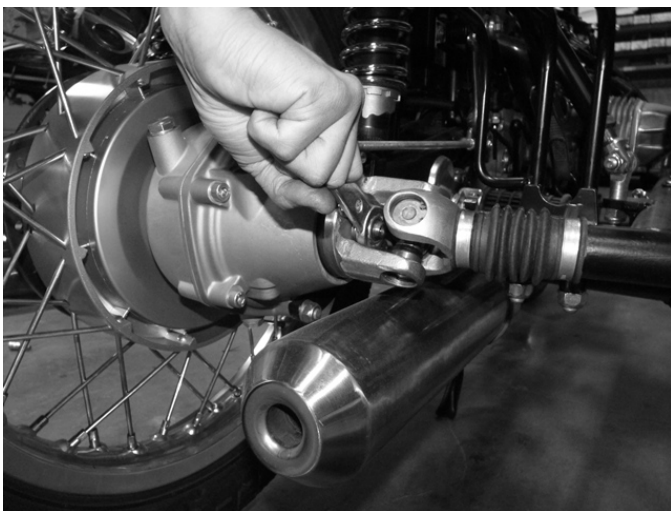

Step 6

Loosen the axle pinch bolt.

REAR WHEEL REMOVAL & INSTALLATION (CONT.)



Step 7
Remove the axle.

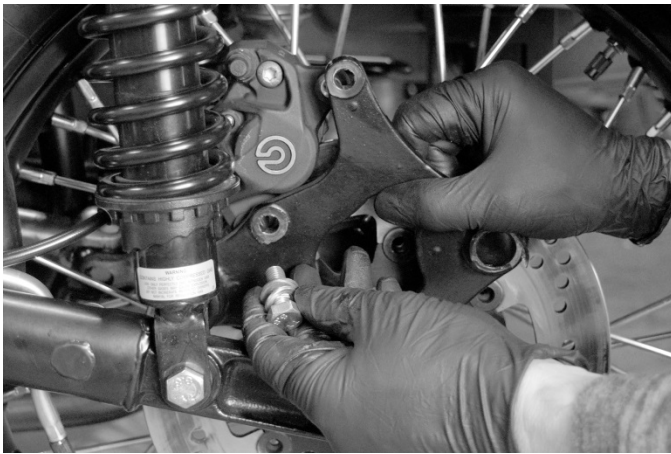

Step 8
Pull brake caliper mounting plate back and remove caliper bolts.



Step 9
Remove brake mounting plate.

REAR WHEEL REMOVAL & INSTALLATION (CONT.)



Step 10

Remove the rear wheel by tilting it outwards towards you and rolling it back as shown.

NOTE

Re-install the rear wheel in reverse order.
Torque all fasteners to specification.

SIDECAR WHEEL REMOVAL & INSTALLATION



Step 1

Remove the sidecar brake caliper.



Step 2

Carefully remove the sidecar hub cap.



Step 3

Remove the axle cotter pin and axle nut.

Step 4

Re-install the sidecar wheel in reverse order.

USING THE SPARE WHEEL



NOTE

THE SPARE WHEEL COMES EQUIPPED FOR USE ON THE REAR POSITION.

Step 1

Remove the rear wheel and rear brake rotor.

Step 2

Install the brake rotor on the spare wheel and torque to specification.

Step 3

Install the spare wheel on the motorcycle.

WHEEL SPOKE MAINTENANCE



The wheel spokes should be checked on a regular basis and per the maintenance intervals.

Check spoke tension by lightly tapping each spoke and listening to the ring. Loose spokes will make a low flat sound.

Step 1

Tap each spoke and compare the sound from one to another.

Step 2

Tighten spokes as needed. If spokes require more than $\frac{1}{2}$ turn to tighten you may need to remove the tire and have the wheel professionally trued.



WHEEL BEARING REPLACEMENT & DIAGRAMS

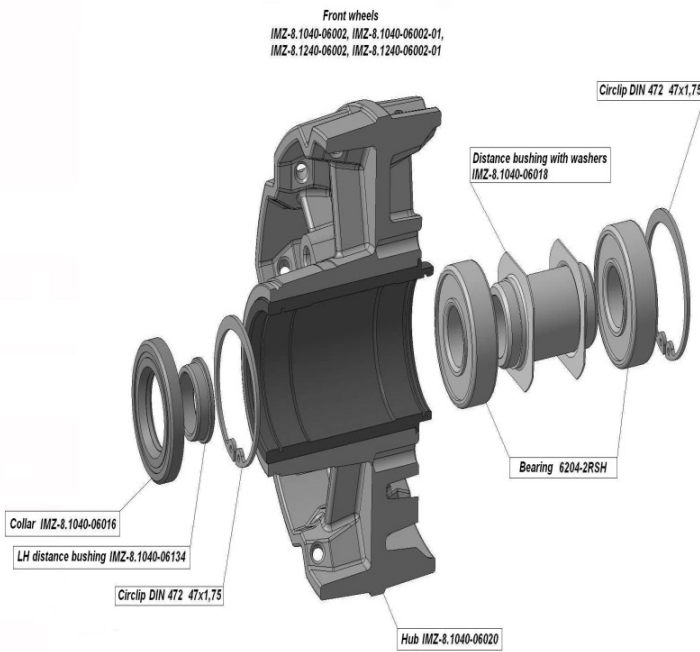

The wheel bearings are sealed type and cannot be serviced, only replaced.

The bearings should be inspected and replaced per the maintenance intervals.

Step 1

Remove the wheel.

Step 2

Remove the dust seals and retaining clips.

Step 3

Carefully drive the bearings out of the hub and replace.

Step 4

Re-install in reverse order replacing the dust seals as needed.

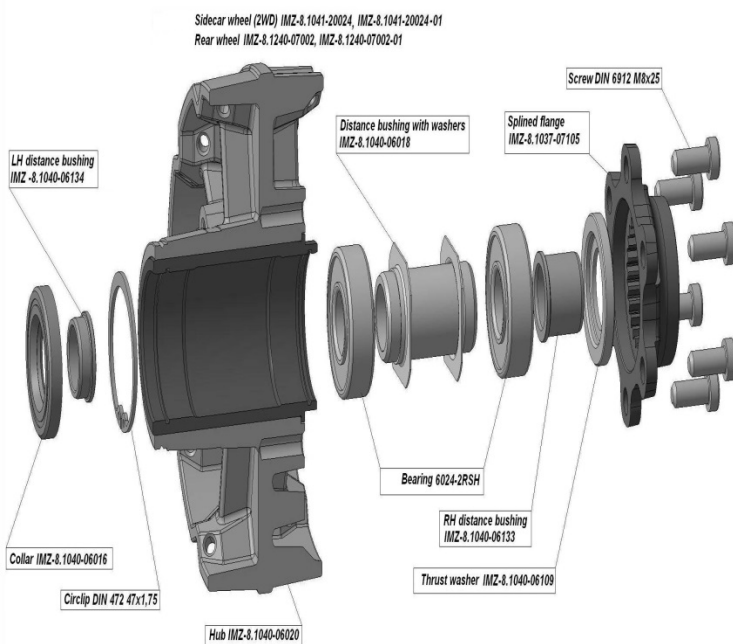

NOTE

WHEEL BEARINGS SHOULD BE INSPECTED AND REPLACED MORE FREQUENTLY THAN OUTLINED IN THE MAINTENANCE SCHEDULE WHEN THE MOTORCYCLE IS USED OFF ROAD OR IN ADVERSE WEATHER ON A REGULAR BASIS.

CAUTION

FAILURE TO REPLACE THE WHEEL BEARINGS WHEN NEEDED CAN DAMAGE THE WHEEL HUB AND AXLE.

WARNING

DAMAGED AND/OR WORN BEARINGS CAN PREVENT THE WHEEL FROM ROTATING FREELY.

TIRE & TUBE REPLACEMENT

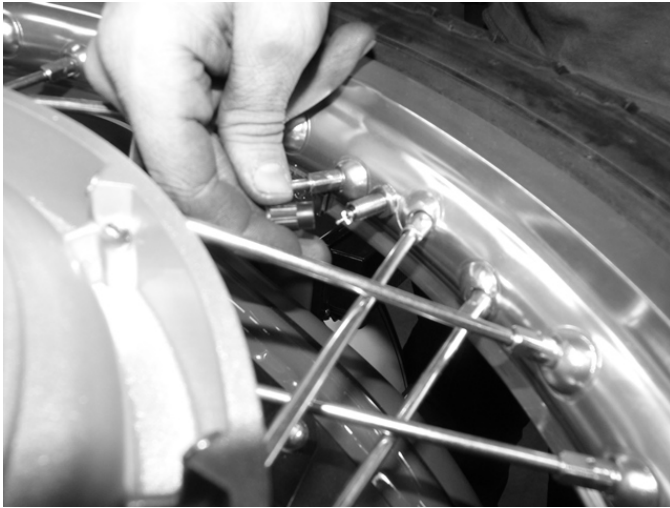

Step 1

Remove the valve stem and deflate the tire.



Step 2

Using the provided tire spoons in your tool kit carefully remove one side of the tire from the rim.



Step 3

Remove the tube from the tire.

Step 4

Remove the tire from the rim.

Step 5

Re-install the tire in reverse order; be careful not to pinch the tube during installation.

NOTE

WHEN INFLATING THE TIRE, BE SURE THE TIRE BEAD IS FULLY SEATED AND EVEN AROUND THE RIM.

SIDECAR ALIGNMENT

The sidecar should be installed in a definite position relative to the motorcycle. The position is determined by the camber and toe-in of the motorcycle and the side car wheels. An incorrectly aligned side car will drag the motorcycle to either side and cause extensive tire wear. If the motorcycle is not stable on the road or is difficult to steer, check the alignment. Checking and measuring the alignment should be done on level ground.

Check toe-in of the motorcycle and the side car wheels with two straight bars applied to the side faces of the wheels just below the axles. The toe-in should be 3 to 8mm (2wd models) or 8 to 12mm (1wd models) at the front wheel. When adjusting, unbolt the top of the strut legs fastening the side car to the motorcycle, loosen the bolt clamping the lower rear bracket, and adjust the position of the bracket relative to the rear tube of the side car frame to obtain necessary toe-in of the wheels. Tighten up the bolt fastening the bracket, adjust the length of the strut legs and secure them with bolts.

Check the lean-out of the motorcycle using a level gauge or protractor with a plumb bob and a ruler; standard lean-out is 1-2 degrees. Adjust the two inclined legs by screwing the forks in or out. When the lean-out is correct, the rider will remain vertical while riding on the local roads which may be slightly sloped to assist with water runoff.

Check the toe-in while the motorcycle is running on the road. With the toe-in properly adjusted, the motorcycle will not pull to either side while running at normal road speed. If it pulls to the right, increase the toe-in, if it pulls to the left, decrease the toe-in.

CAUTION

DOUBLE CHECK FOR CORRECT TOE-IN BEFORE MAKING ANY CHANGE TO LEAN-OUT.

SIDECAR ALIGNMENT DIAGRAM

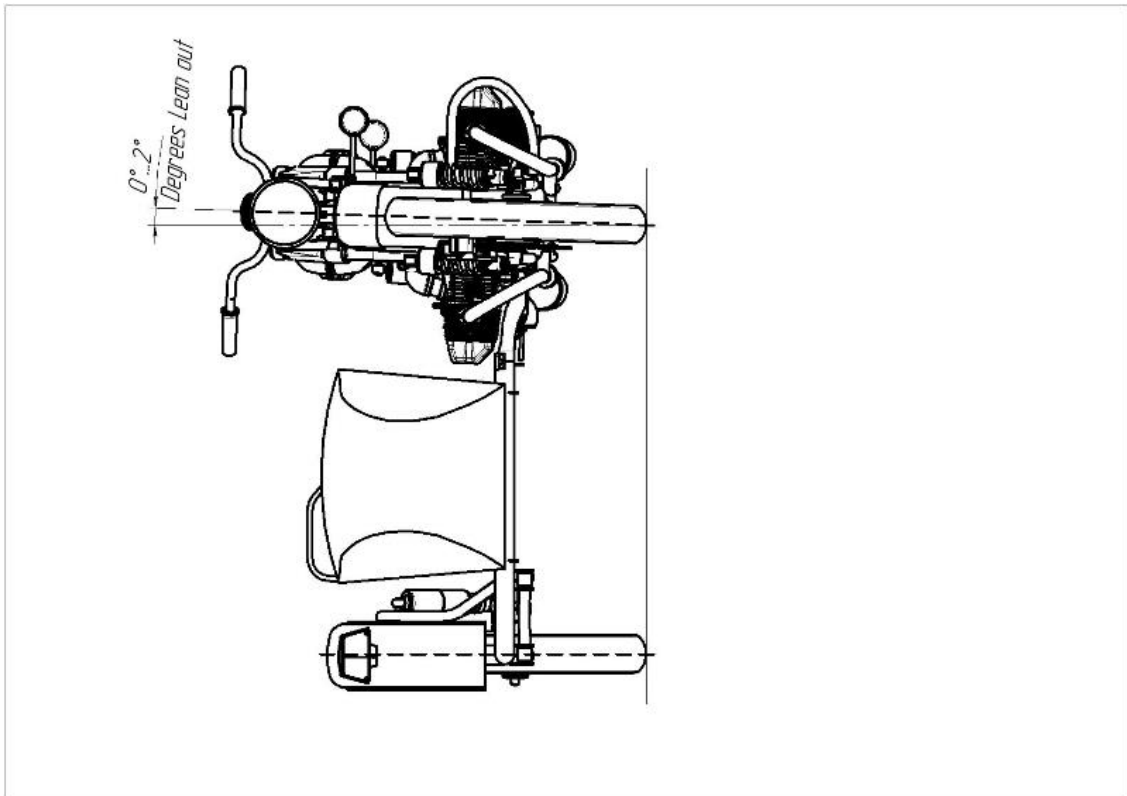
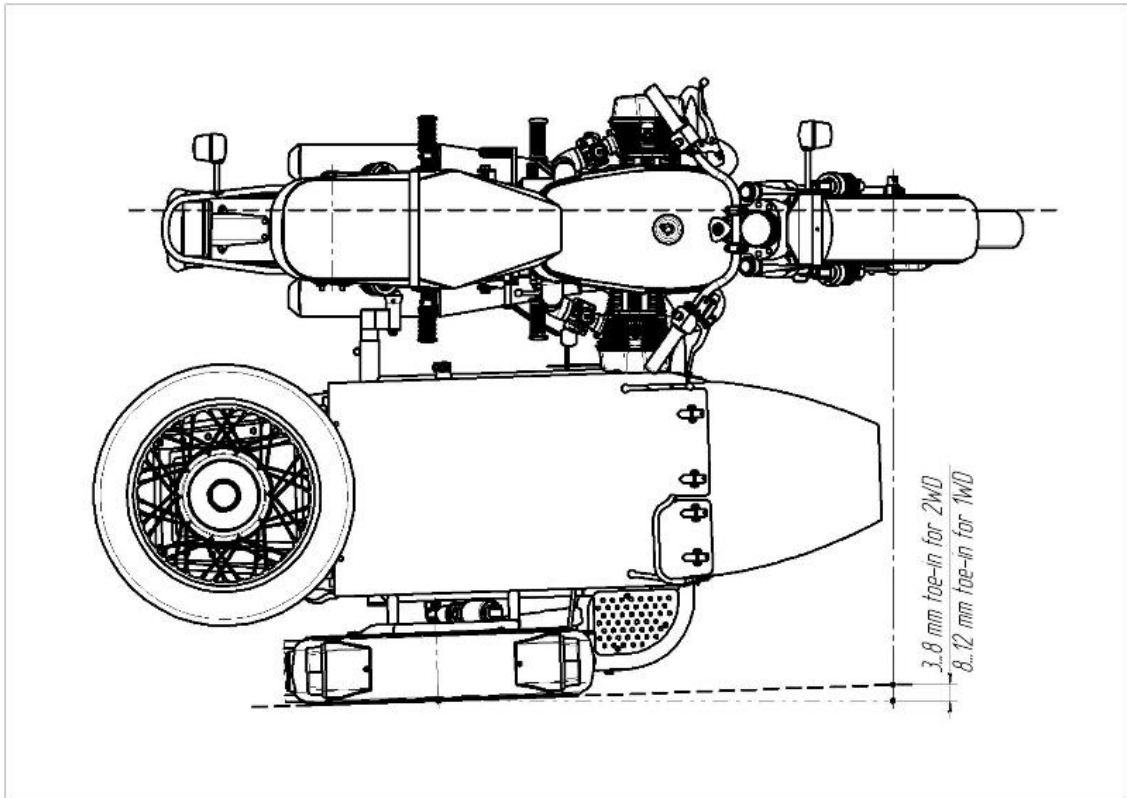

6. Electrical

	Page
Lamp & Bulb Replacement	6-2
Battery Maintenance & Replacement	6-6
Fuse & Relay Locations	6-9
Sidecar Fuse & Relay Locations	6-10
Starter	6-11
Alternator	6-11
ECU Data Port	6-11

LAMP & BULB REPLACEMENT (HEADLIGHT)



Headlight Replacement

Step 1

Remove the lamp retaining ring screw and pull the lamp out of the bucket.

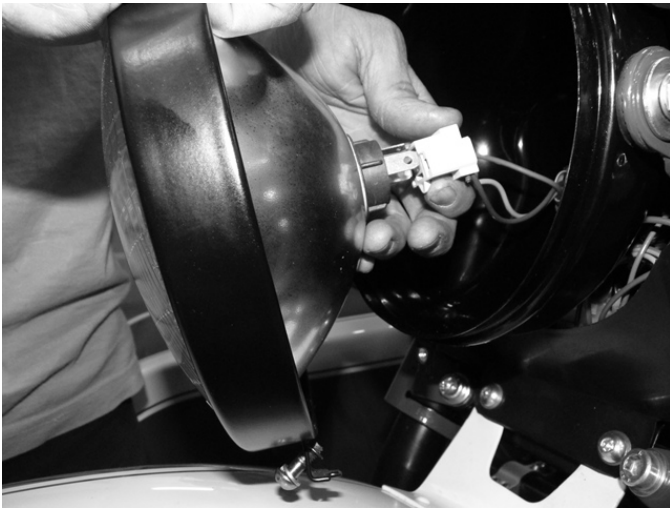

Step 2

Disconnect the lamp.



Step 3

Carefully remove the lamp retaining clips and replace lamp.

Step 4

Re-install in reverse order.

WARNING

ALWAYS WEAR EYE PROTECTION WHEN REMOVING LAMP RETAINING CLIPS.

WARNING

IT IS UNSAFE TO OPERATE YOUR MOTORCYCLE WITHOUT A FUNCTIONING HEADLIGHT.

LAMP & BULB REPLACEMENT (TAIL LIGHT)



Tail Light Replacement

Step 1

Remove the tail light lens retaining screws.



Step 2

Inspect and replace bulbs as needed. The upper bulb in the running/brake lamp and the lower is the license plate lamp.

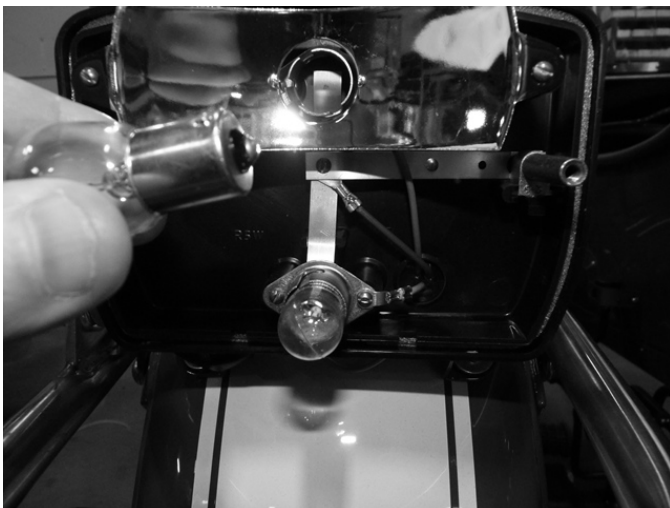

Step 3

To remove the bulb twist and pull.

Step 4

Re-install the bulbs in reverse order.

NOTE

TO HELP PREVENT CORODED CONTACTS USE DIELECTRIC GREASE.

WARNING

IT IS UNSAFE TO OPERATE YOUR MOTORCYCLE WITHOUT A FUNCTIONING TAIL AND BRAKE LIGHT.

LAMP & BULB REPLACEMENT (TURN SIGNALS)



Turn Signal Bulb Replacement

Step 1

Remove the turn signal lens retaining screws.

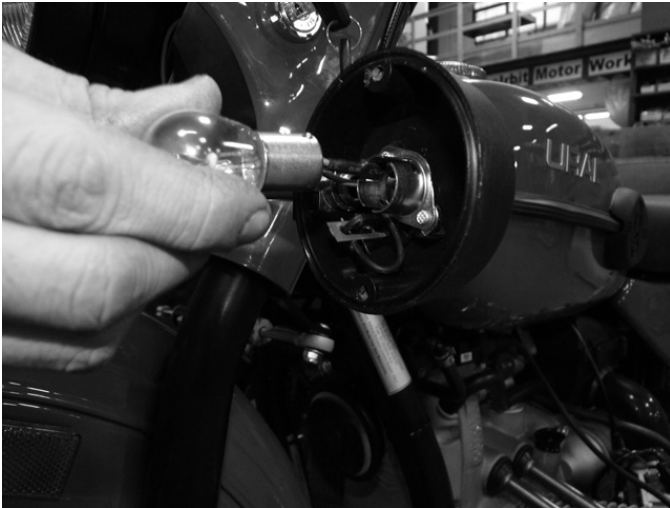

Step 2

Inspect and replace bulbs as needed.

Step 3

To remove the bulb twist and pull.



Step 4

Re-install the bulbs in reverse order.

NOTE

TO HELP PREVENT CORODED CONTACTS USE DIELECTRIC GREASE.

WARNING

IT IS UNSAFE TO OPERATE YOUR MOTORCYCLE WITHOUT FUNCTIONING TURN SIGNALS.

LAMP & BULB REPLACEMENT (SIDECAR LAMPS)



Sidecar Lamps

Step 1

Remove the lens retaining screws.

Step 2

Inspect and replace bulbs as needed.



Step 3

To remove the bulb twist and pull.

Step 4

Be sure to re-install the lens gasket.



Step 5

Re-install the bulbs in reverse order.

NOTE

TAIL LIGHT/BRAKE ON LEFT AND SIGNAL ON RIGHT

NOTE

TO HELP PREVENT CORODED CONTACTS USE DIELECTRIC GREASE.

WARNING

IT IS UNSAFE TO OPERATE YOUR MOTORCYCLE WITHOUT FUNCTIONING SIDECAR LAMPS.

BATTERY MAINTENANCE

Stock battery on the motorcycle should function at ambient air temperature from -40°C to plus 60°C/ 40°F to 140°F.

As the battery is in service:

- Regularly check the voltage for 13.8 - 14.2 V
- Do not allow the battery to discharge.
- Coat bolts, nuts, washers and tips with petroleum jelly or battery grease. Use two wrenches for clamping or undoing the nuts to avoid breaking battery parts.

Before storage, fully charge the battery, wash the battery surface with water and wipe dry, clean the bolts and nuts of dirt.

WARNING

BATTERIES CONTAIN SULFURIC ACID WHICH CAN CAUSE SEVERE BURNS. AVOID CONTACT WITH SKIN, EYS OR CLOTHING.

ANTIDOTE

EXTERNAL – FLUSH WITH WATER.

INTERNAL – DRINK LARGE QUANTITIES OF WATER FOLLOWED BY MILK OF MAGNESIA, VEGETABLE OIL, OR BEATEN EGGS.

CALL DOCTOR IMMEDIATELY

CAUTION

WHEN CHARGING THE BATTERY, DISCONNECT THE NEGATIVE TERMINAL FROM THE BATTERY TO PREVENT DAMAGE TO ELECTRICAL COMPONENTS.

NEVER JUMP START THE MOTORCYCLE!

WARNING

BATTERIES PRODUCE EXPLOSIVE HYDROGEN GAS AT ALL TIMES – ESPECIALLY WHEN BEING CHARGED. KEEP ANY OPEN FLAMES AND/OR SPARKS AWAY FROM THE BATTERY AT ALL TIMES. ALWAYS PROTECT HANDS AND FACE WHEN WORKING ON AND/OR NEAR A BATTERY.

KEEP BATTERIES OUT OF REACH OF CHILDREN AND PETS!

BATTERY REPLACEMENT



Step 1

Disconnect the white negative (-) battery cable.



Step 2

Disconnect the positive (+) battery cable

Step 3

Remove the battery hold down straps.

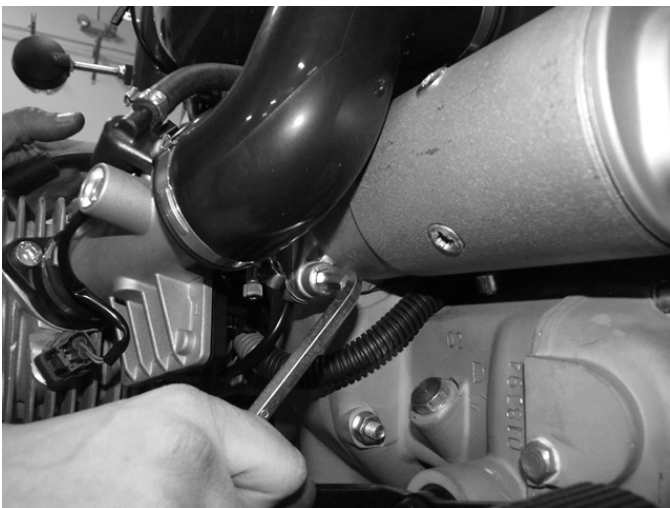

Step 4

Loosen both the upper and lower starter bolts to allow clearance for battery removal.

CAUTION

ALWAYS DISCONNECT THE NEGATIVE (-) BATTERY CABLE FIRST TO AVOID SHORTING THE BATTERY.

WARNING

SHORTING THE BATTERY TERMINALS COULD RESULT IN A FIRE.

BATTERY REPLACEMENT (CONT.)



Step 5

Carefully slide the battery out between the frame tube and air box.



Step 6

Re-install in reverse order by sliding the battery back into place and reconnecting all straps and cables.



Step 7

Be sure to re-tighten the starter bolts.

CAUTION

ALWAYS RECONNECT THE POSITIVE (+) BATTERY CABLE FIRST TO AVOID SPARKS.

NOTE

USE DIELECTRIC GREASE ON THE BATTERY CONNECTIONS TO PREVENT CORROSION.

FUSE & RELAY LOCATIONS

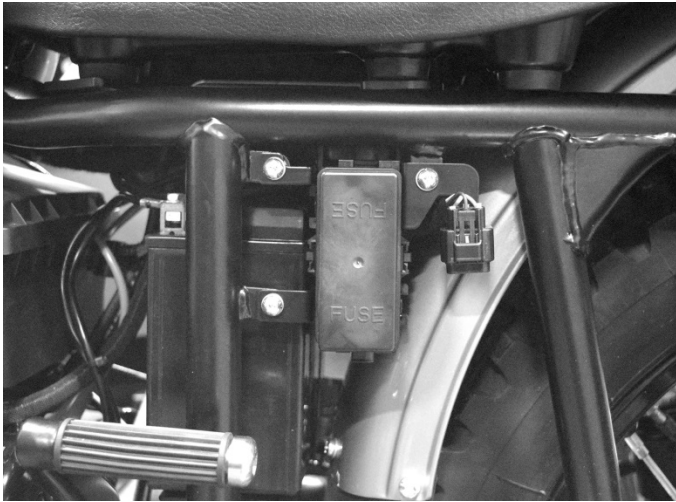

Fuse Box Main

The main motorcycle fuse box is located under the left side panel.

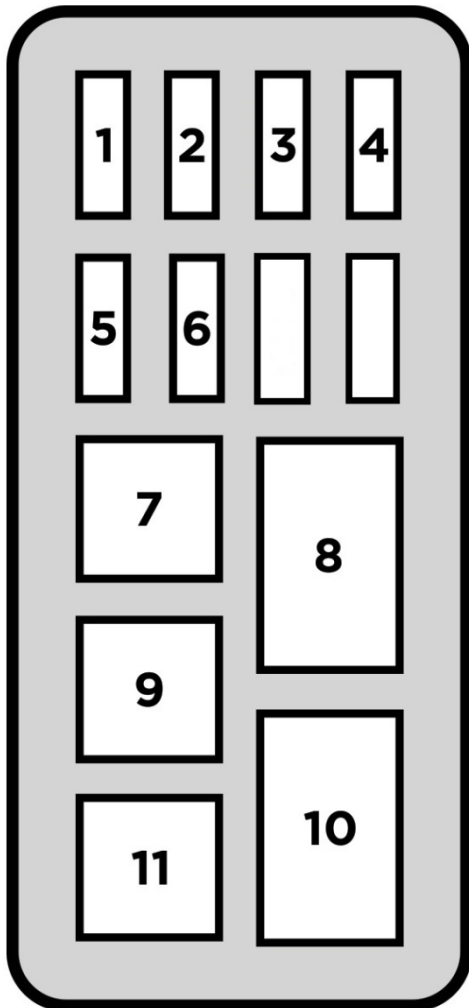

Fuse Box Diagram

This diagram shows the position and function for each fuse and relay in the fuse box.

- | | |
|-----------------------------|-----|
| 1. ECU Power | 10a |
| 2. ECU Relay Power | 15a |
| 3. Ignition/Starter/Signals | 15a |
| 4. Brake Lights/Horn/EVAP | 15a |
| 5. Lights/High Beam | 15a |
| 6. Parking Lights | 15a |
| 7. Headlight Relay | |
| 8. ECU Relay | |
| 9. Starter Lock-out Relay | |
| 10. Lighting Relay | |
| 11. Starter Relay | |

FUSE & RELAY LOCATIONS (CONT.)



Turn Signal Relay

The turn signal relay is located behind the headlight bucket. To access this relay you must first remove the headlight bucket assembly.

SIDECAR FUSE & RELAY LOCATIONS



Fuse Box Sidecar

The sidecar fuse box is located on the left hand interior body panel of the sidecar.

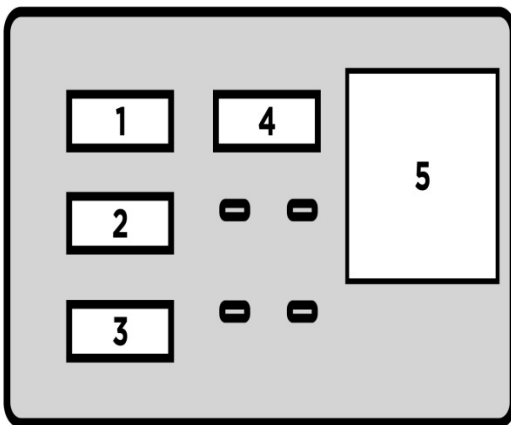

Fuse Box Diagram

This diagram shows the position and function for each fuse and relay in the fuse box.

- | | |
|----------------------------|------------|
| 1. Power Outlet | 15a |
| 2. Accessory Switch | 15a |
| 3. Accessory | 15a |
| 4. Spotlight | 15a |
| 5. Spotlight Relay | |

ELECTRIC STARTER

The starter must provide 300-400 rpm to start the engine and requires a well maintained battery. If battery is below required the voltage the electric starter may not operate efficiently. If the battery becomes low you may need to use the kick starter.

ALTERNATOR

This motorcycle is equipped with a Denso Alternator.

Specifications:

Rated Voltage 12V

Rated Output 40A, 480W

Peak Output 560W @ 14V

Testing the Alternator on the Motorcycle

If no test bench is available, check the output of the alternator with the engine running.

- Connect the voltmeter to positive and negative terminals of the storage battery
- Start the engine
- While starting the voltage will drop to as low as 9.5 V
- At 3500-4000 rpm output voltage should be 13.5-14.5 VDC

In the course of daily inspection, check the fastening of wires to the alternator terminals and fastening of the alternator on the engine crankcase.

ECU DATA PORT

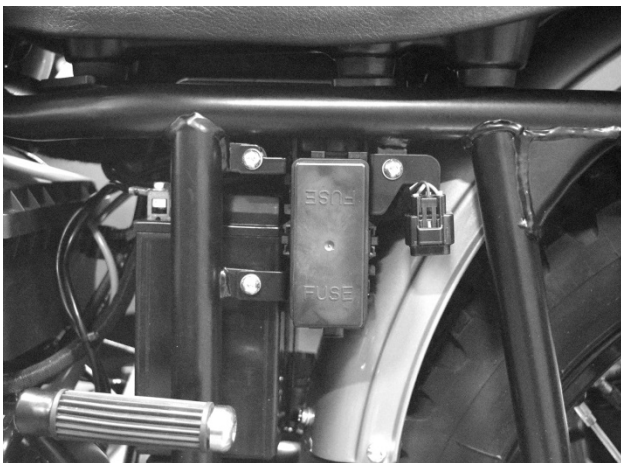

The ECU Data port is located behind the left side panel. This data port is intended for:

DEALER ONLY EFI DIAGNOSTICS

The data port has a protective cap that should be left in place to prevent debris from contaminating the connector.

7. EFI Troubleshooting

	Page
Engine Management (MIL Blink Codes)	7-2
Service Notes	7-4

URAL ENGINE MANAGEMENT SYSTEM BLINK DIAGNOSTICS

Introduction

A basic blink code system has been implemented on the Ural EFI bikes to aid EMS (Engine Management System) diagnostics without the need for an additional computer diagnostic tool, greatly helping the user when during travels. When activated, the MIL (malfunction indicator lamp) blinks out a code sequence relating to the fault.

Operation

When the MIL is continuously lit with the key on, an EMS fault has occurred. Activate the blink code by turning the key on and toggling the key switch 3 times (Off->On->Off->On->Off->On) within 10 seconds. MIL will blink the code "02" indicating the ECU is in blink mode.

Once in blink mode, the ECU will blink the code "02" first and then blink a unique code for each possible system fault in a consecutive fashion, before cycling back to the beginning.

The ECU will remain in this mode until the Key switch is turned off for more than 10 seconds.

Blink Code	Fault Code (P)	Fault Description	MIL Activation Criteria
13	P0107	Pressure sensor open or short to GND	Detected circuit open
13	P0108	Pressure sensor short to battery	Detected circuit short to battery
28	P0117	Engine temp sensor short to ground	Detected circuit short to GND
28	P0118	Engine temp sensor open	Detected circuit open
46	P0563	Battery voltage high	Voltage measured above 16V
15	P0122	TPS open or short to GND	Detected circuit open
15	P0123	TPS short to battery	Detected circuit short to battery
24	P0131	NB O2 open or short to GND	Detected circuit short to GND
24	P0132	NB O2 short to battery	Detected circuit short to battery
11	P0231	Fuel pump open or short to GND	Detected circuit open
17	P0232	Fuel pump short to battery	Detected circuit short to battery
44	P0601	EEPROM error	Fault detected
39	P0261	Injector open or short to GND	Detected circuit open
39	P0262	Injector short to battery	Detected circuit short to battery
33	P1351	Ignition Coil open or short to GND	Detected circuit open
33	P0351	Ignition Coil short to battery	Detected circuit short to battery
34	P0335	Crank sensor error	Signal miss counted while the engine is running
35	P0298	Engine over heat	Temperature measured above 170°C
36	P1352	Cyl2 Ignition Coil open or short to GND	Detected circuit open
38	P0352	Cyl2 Ignition Coil short to battery	Detected circuit short to battery
47	P0264	Cyl2 Injector open or short to GND	Detected circuit open
48	P0265	Cyl2 Injector short to battery	Detected circuit short to battery
12	P1335	Crank sensor open or short to GND	Running engine without signal detected.
51	P0135	NB O2 heater short to battery	Detected circuit short to battery
52	P1135	NB O2 heater open or short to GND	Detected circuit open
31	P0508	ISC open or short to GND	Detected circuit open
32	P0509	ISC short to battery	Detected circuit short to battery
37	P0505	Step Motor Rationality	Self-diag function of the control IC
61	P1509	Step Motor Output Over Temperature	Self-diag function of the control IC
41	P0151	O2B open or short to GND	Detected circuit short to GND or Open
42	P0152	O2B short to battery	Detected circuit short to battery
62	P0155	O2B heater short to battery	Detected circuit short to battery
63	P1155	O2B heater open or short to GND	Detected circuit short to GND or Open
65	P0444	Canister purge valve open or short to GND	Detected circuit open
66	P0445	Canister purge valve short battery	Detected circuit short to battery

SERVICE NOTES

8. Warranty Information

	Page
Warranty Agreement	8-2
Warranty Disclaimers	8-3
Limited Emissions Warranty	8-5
California Emissions Statement	8-7
Extended Warranty	8-8
Spare Parts and Accessories Warranty	8-8
Reporting Safety Defects	8-9

URAL MOTORCYCLES LIMITED WARRANTY

Ural Motorcycles warrants to the first retail purchaser of the URAL motorcycle from an authorized dealer and each subsequent owner that the motorcycle is free from defects in materials and workmanship for the period stated below.

To Qualify For This Warranty

- The URAL® motorcycle must be purchased from a dealer within the United States or Canada who is authorized by Ural Motorcycles to sell motorcycles (see www.imz-ural.com for a complete list of authorized dealers).
- Prior to delivery to the purchaser, the dealer who is authorized by Ural Motorcycles to sell motorcycles must perform the complete set-up and pre-delivery procedures.

Warranty Time Period for Current Model Year

- Duration of Ural Motorcycles Limited Warranty is 24 months, starting with the earlier of (a) the date the motorcycle is sold to the first retail purchaser and the warranty registration card is received by Ural Motorcycles, or (b) after 12 months in the selling dealer's inventory.
- There is no mileage limitation.
- Any unexpired portion of this limited warranty will be transferred to subsequent owners, upon the resale of the motorcycle during the limited warranty period.

Warranty Coverage

- To obtain warranty service, return your motorcycle at your expense within the limited warranty period to an authorized Ural dealer. The authorized Ural dealer should be able to provide warranty service during normal business hours, depending upon the workload of the authorized dealer's service department and the availability of necessary parts.
- Ural Motorcycles will repair or replace, at its option, any parts (including parts of the emission control systems) that are found to be defective in material or workmanship under normal use for the applicable time period.
- In cases when warranty repair takes longer than 14 days, the warranty time period (see Warranty Time Period) is extended for the period of time required to complete the repairs, during which the motorcycle could not be ridden.
- Ural Motorcycles will reimburse non-URAL repair shops performing warranty repairs only if all the warranty processing and approval procedures are completely fulfilled and/or carried out according to Ural Motorcycles guidelines (see Warranty Claim Filing Procedures).

WARRANTY DISCLAIMERS LIMITATIONS & EXCLUSIONS

Ural Motorcycles Disclaims Any Responsibility For:

- Loss of time due to warrantable issues and/or repairs.
- Loss of use of motorcycle dues to warrantable repairs.
- Transportation expenses including, but not limited to, towing and/or rentals.
- Any other incidental or consequential damages and/or expenses.

THERE IS NO OTHER EXPRESSED WARRANTY (OTHER THAN THE SEPARATE EMISSIONS LIMITED WARRANTIES) ON THE MOTORCYCLE.

Any implied warranty of merchantability or fitness for particular purpose is limited to the duration of the express warranty, or to the duration set forth in your state's warranty statutes, whichever is shorter.

State Laws May Vary

The previous listed limitations or exclusions may not apply to a motorcycle because of state laws. Some states may not allow limitations on how long an implied warranty lasts. Some states may not allow exclusion or limitation of incidental or consequential damages.

These Warranties Do Not Cover:

1. Failures or required services that is not due to a defect in material or factory workmanship
2. Parts or accessories affected or damaged by:
 - Lack of required maintenance
 - Owner abuse
 - Accident and/or collision
 - Misuse
 - Normal wear
 - Neglect
 - Improper installation
 - Unsuitable use in an application for which the part was not designed
 - The incorporation or use of unsuitable attachments or parts
 - The unauthorized alteration of any part or system
 - Deterioration from the elements
 - Failure to follow running-in (break-in) procedure
3. Replacement of expendable maintenance items including, but not limited to:
 - Spark plugs
 - Filters
 - Lubricants
 - Compliance fittings (throttle body mounting flanges)
 - Tires
 - Gaskets
 - Fuel line
 - Fuses
 - Bulbs
 - Battery (after 1 year in service)
4. Paint and/or decal fading, peeling, blistering, chipping or rusting.
5. Surface rust or corrosion on the chassis and/or drivetrain.

The Following Activities Will VOID Warranty Coverage:

- Any operation or use outside of that described in Owner's Manual
- Racing
- Competition
- Rental and/or other commercial use
- Alteration of the odometer reading
- Towing

Dealer's Warranty Responsibilities:

- Thoroughly check and road test new units before delivery.
- Complete and send Warranty Registration and Card of Delivery to Ural Motorcycles within 3 business days of the sale of motorcycle.
- Accept all eligible motorcycles for warranty service regardless of selling dealer.
- Keep records of all warranty work.
- Attend service schools and annual dealer meetings as provided by Ural Motorcycles.
- Submit warranty claims to Ural Motorcycles within 10 business days of the repair date.
- Send failed parts and/or parts assemblies for an inspection to Ural Motorcycles within 3 (three) business days upon Ural Motorcycle's request at Ural Motorcycles shipping expense.
- Provide digital pictures of failed and/or defective parts and assemblies with all claims.

Owner's Warranty Responsibilities:

- As the owner of Ural motorcycle, you are responsible for the performance of the required maintenance listed in your owner's manual. URAL recommends that you retain all receipts covering maintenance on your motorcycle, but URAL cannot deny warranty solely for the lack of receipts or for your failure to ensure the performance of all scheduled maintenance.
- You are responsible for presenting your motorcycle to an URAL dealer as soon as a problem exists. The warranty repairs should be completed in a reasonable amount of time not to exceed 30 (thirty) days.
- As the motorcycle owner, you should also be aware that URAL may deny you warranty coverage if your motorcycle or a part has failed due to abuse, neglect, improper maintenance or unapproved modifications.

LIMITED WARRANTY ON EMISSION CONTROL SYSTEM

Ural Motorcycles, 14700 NE 95th St. Suite 102, Redmond, WA 98052, USA (hereinafter URAL) warrants that each new 2004 and later Ural motorcycle that includes as standard equipment a headlight, taillight and stoplight, and is street legal:

A. is designed, built and equipped so as to conform at the time of initial retail purchase with all applicable regulations of the United States Environmental Protection Agency, and the California Air Resources Board; and
B. is free from defects in material and workmanship which cause such motorcycle to fail to conform with applicable regulations of the United States Environmental Protection Agency or the California Air Resources Board for a period of use, depending on the engine displacement: of 30,000 kilometers (18,641 miles), if the motorcycle's engine displacement is 280 cubic centimeters or greater or 5 (five) years from the date of initial retail delivery, whichever first occurs.

I. COVERAGE

Warranty defects shall be remedied during customary business hours at any authorized URAL motorcycle dealer located within the United States of America in compliance with the Clean Air Act and applicable regulations of the United States Environmental Protection Agency and the California Air Resources Board. Any part or parts replaced under this warranty shall become the property of URAL. In the State of California only, emission related warranted parts are specifically defined by the state's Emission Warranty Parts List.

These warranted parts are:

- Injectors
- Electronic valves
- Air box
- Air cleaner element
- Spark plug
- Ignition coil
- Ignition control valve module
- Catalyst
- Carbon absorber

In the State of California only, Emission Control System emergency repairs, as provided for in the California Administrative Code, may be performed by other than an authorized URAL dealer. An emergency situation occurs when an authorized URAL dealer is not reasonably available, a part is not available within 30 (thirty) days, or a repair is not complete within 30 days. Any replacement part can be used in an emergency repair. URAL will reimburse the owner for the expenses, including diagnosis, not to exceed URAL's suggested retail price for all warranted parts replaced and labor charges based on URAL's recommended time allowance for the warranty repair and the geographically appropriate hourly labor rate. The owner may be required to keep receipts and failed parts in order to receive compensation.

II. LIMITATIONS

This Emission Control System warranty shall not cover any of the following:

A. Repair or replacement required as a result of

- (1) Accident
- (2) Misuse
- (3) Repairs improperly performed or replacements improperly installed
- (4) Use of replacement parts or accessories not conforming to URAL specifications which adversely affect performance and/or
- (5) Use in competitive racing or related events.

A. Inspections, replacement of parts and other services and adjustments required for required maintenance

B. Any motorcycle on which the odometer mileage has been changed so that actual mileage cannot be readily determined.

III. LIMITED LIABILITY

A. The liability of URAL under this Emission Control System Warranty is limited solely to the remedying of defects in material or workmanship by authorized URAL motorcycle dealers at its place of business during customary business hours. This warranty does not cover inconvenience or loss of use of the motorcycle or transportation of the motorcycle to or from the URAL dealer. URAL SHALL NOT BE LIABLE FOR ANY OTHER EXPENSES, LOSS OR DAMAGE, WHETHER DIRECT, INCIDENTAL, CONSEQUENTIAL OR EXEMPLARY ARISING IN CONNECTION WITH THE SALE OR USE OF OR INABILITY TO USE THE URAL MOTORCYCLE FOR ANY PURPOSE. SOME STATES DO NOT ALLOW THE EXCLUSION OR LIMITATION OF ANY INCIDENTAL OR CONSEQUENTIAL DAMAGES, SO THE ABOVE LIMITATIONS MAY NOT APPLY TO YOU.

B. NO EXPRESS EMISSION CONTROL SYSTEM WARRANTY IS GIVEN BY URAL EXCEPT AS SPECIFICALLY SET FORTH HEREIN. ANY EMISSION CONTROL SYSTEM WARRANTY IMPLIED BY LAW, INCLUDING ANY WARRANTY OF MERCHANTABILITY OR FITNESS FOR A PARTICULAR PURPOSE, IS LIMITED TO THE EXPRESS EMISSION CONTROL SYSTEM WARRANTY TERMS STATED IN THIS WARRANTY. THE FOREGOING STATEMENT OF WARRANTY ARE EXCLUSIVE AND IN LIEU OF ALL OTHER REMEDIES. SOME STATES DO NOT ALLOW LIMITATIONS ON HOW LONG AN IMPLIED WARRANTY LASTS SO THE ABOVE LIMITATIONS MAY NOT APPLY TO YOU.

C. No dealer is authorized to modify this URAL Limited Emission Control System Warranty.

IV. LEGAL RIGHTS

THIS WARRANTY GIVES YOU SPECIFIC LEGAL RIGHTS, AND YOU MAY ALSO HAVE OTHER RIGHTS, WHICH VARY FROM STATE TO STATE.

V. THIS WARRANTY IS IN ADDITION TO THE URAL LIMITED MOTORCYCLE WARRANTY.

VI. ADDITIONAL INFORMATION

Any replacement part that is equivalent in performance and durability may be used in the performance of any maintenance or repairs. However, URAL is not liable for these parts. The owner is responsible for the performance of all required maintenance. Such maintenance may be performed at a service establishment or by any individual. The warranty period begins on the date the motorcycle is delivered to an ultimate purchaser.

CALIFORNIA EMISSION CONTROL SYSTEM WARRANTY STATEMENT

Your Warranty Rights and Obligations

The California Air Resources Board and Ural Motorcycles (hereinafter URAL) are pleased to explain the Emission Control System Warranty on your 2005 and later motorcycle. In California, new motor vehicles must be designed, built and equipped to meet the State's stringent anti-smog standards. URAL must warrant the emission control system on your motorcycle for the periods of time listed below provided there has been no abuse, neglect or improper maintenance of your motorcycle. Your emission control system may include parts such as the carburetor, the ignition system, catalytic converter, and engine computer. Also included may be hoses, belts, connectors and other emission-related assemblies. Where a warrantable condition exists, URAL will repair your motorcycle at no cost to you including diagnosis, parts and labor.

Manufacturer's Warranty Coverage

Class III motorcycles (280cc and larger): for a period of use of five (5) years or 30,000 kilometers (18,641 miles), whichever first occurs. If an emission-related part on your motorcycle is defective, the part will be repaired or replaced by URAL. This is your emission control system DEFECTS WARRANTY.

Owner's Warranty Responsibilities

- As the owner of Ural motorcycle, you are responsible for the performance of the required maintenance listed in your owner's manual. URAL recommends that you retain all receipts covering maintenance on your motorcycle, but URAL cannot deny warranty solely for the lack of receipts or for your failure to ensure the performance of all scheduled maintenance.
- You are responsible for presenting your motorcycle to an URAL dealer as soon as a problem exists. The warranty repairs should be completed in a reasonable amount of time not to exceed 30 (thirty) days.
- As the motorcycle owner, you should also be aware that URAL may deny you warranty coverage if your motorcycle or a part has failed due to abuse, neglect, improper maintenance or unapproved modifications.

If you have any questions regarding your warranty rights and responsibilities, you should contact Ural Motorcycles at 1-425-702-8484 or the California Air Resource Board at 9528 Telstar Avenue, El Monte, CA 91731.

EXTENDED WARRANTY

To Qualify For The Ural Extended Warranty:

- The URAL Extended Warranty must be purchased from a Dealer within the United States who is authorized by IMWA, Inc. to sell motorcycles.
- The customer may purchase the Ural Extended Warranty, at any time, prior to the expiration of the initial factory two (2) year warranty.

Warranty Time Period

- Duration: One (1) years parts and labor.
- Coverage begins the date after our standard two (2) year warranty ends.

Warranty Coverage

- The Ural extended warranty will follow the same terms and conditions of the current existing Manufactures Warranty.
- There is no mileage limitation.

SPARE PARTS AND ACCESSORIES WARRANTY

Ural Motorcycles provides limited warranty for spare parts and accessories for the following period of time starting from the time of purchase of the parts by a dealer or retail customer:

- Engine – 12 months
- Gearbox – 12 months
- Final drive – 12 months
- Alternator – 6 months
- Starter – 6 months
- EFI Components – 6 months
- All other parts and accessories - 30 days

The above applies ONLY in cases when a dealer or retail customer identifies defects before using parts and/or accessories or these defects are identified during use AND provided these parts and/or accessories have been properly installed by Ural Motorcycles or an authorized Ural dealer.

Irbit Motorworks of America, Inc.
14700 Ne 95th St. Suite 102
Redmond, WA 98052

REPORTING SAFETY DEFECTS

If you believe that your vehicle has a defect which could cause a crash or could cause injury or death, you should immediately inform the National Highway Traffic Safety Administration (NHTSA) in addition to notifying Irbit Motorworks of America, Inc.

If NHTSA receives similar complaints, it may open an investigation, and if it finds that a safety defect exists in a group of vehicles, it may order a recall and remedy campaign. However, NHTSA cannot become involved in any individual problems between you, your dealer, or Irbit Motorworks of America, Inc.

To contact NHTSA you may either call the Auto Safety Hotline toll-free at:

1-800-424-9393 (366-0123 in Washington, DC area).

Or write to:

NHTSA
U.S. DEPARTMENT of TRANSPORTATION
400 7th Street SW, (NSA-11)
Washington, DC 20590

You can also obtain other information about motor vehicle safety from the Hotline.

9. Emission Control Information

	Page
Crankcase Emission Diagram	9-2
California Emission Control Diagram	9-3
Vehicle Emission Control Label	9-4

CRANKCASE EMISSION DIAGRAM

CLOSED CRANKCASE:

No crankcase emissions will be discharged directly into the ambient atmosphere throughout the useful life by any vehicle to be covered by EPA Certification.

Crankcase exhaust emitted by the timed breather is routed to the air filter box and ends prior to the filter. The crankcase exhaust is recycled through the air filter and inducted back into the engine.

Please see the diagram below:

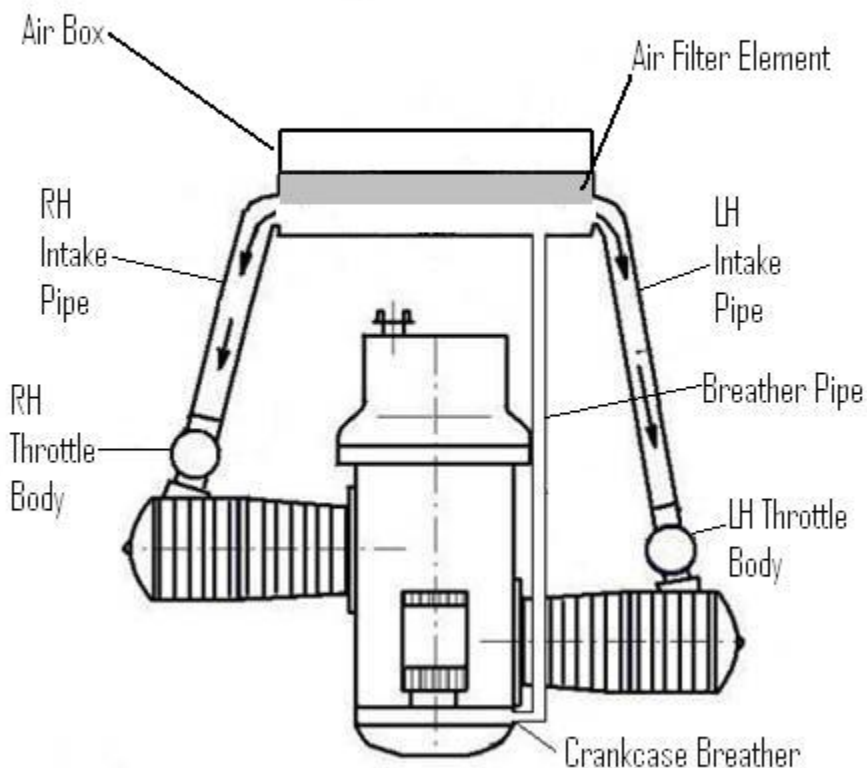

NOTE

IT IS AGAINST FEDERAL LAW TO TAMPER WITH OR REMOVE EMISSION RELATED COMPONENTS.

CALIFORNIA EMISSION CONTROL DIAGRAM

EVAPORATIVE EMISSION CONTROL:

All models sold and shipped into the state of California are equipped with an evaporative emission control system. This system prevents fuel vapors from being discharged directly into the ambient atmosphere throughout the useful life.

Evaporative emission are routed from the fuel tank through a carbon canister to the air box and controlled by an electrical valve. The evaporative emissions are recycled through the air filter and inducted back into the engine.

Please see the diagram below:

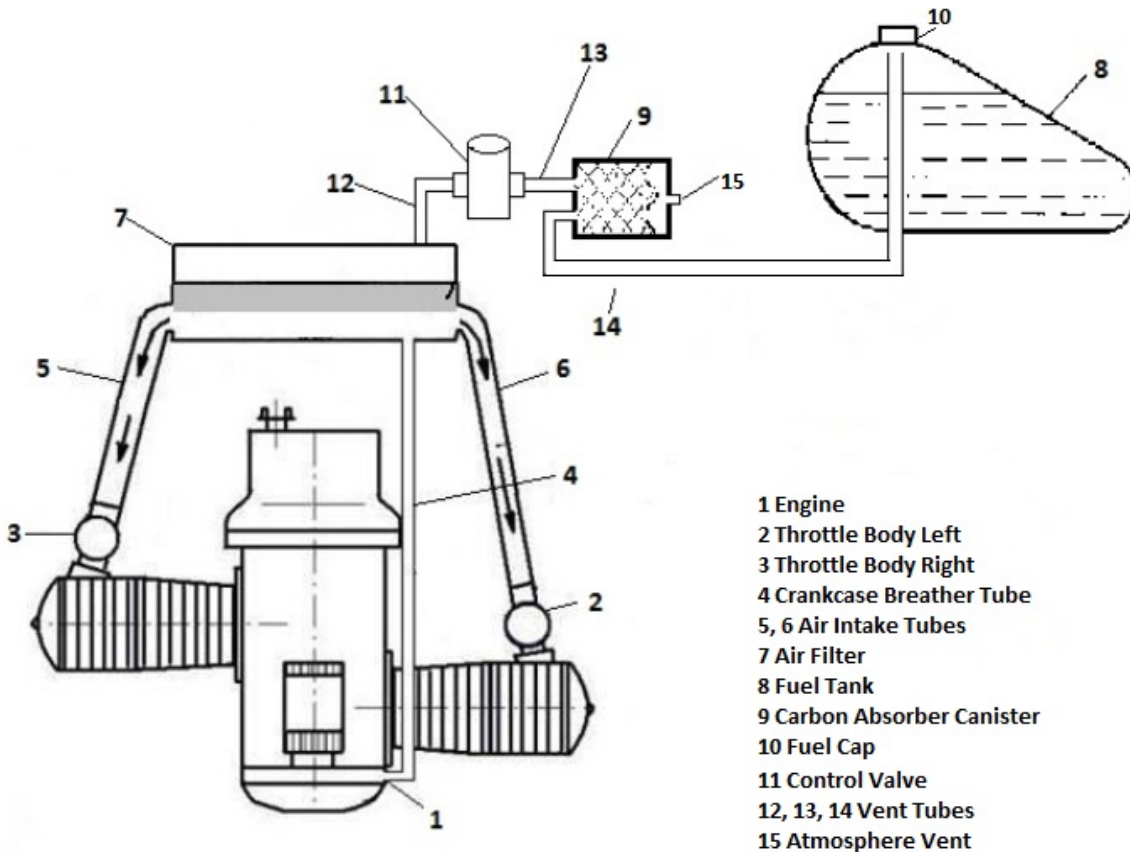

NOTE

IT IS AGAINST FEDERAL LAW TO TAMPER WITH OR REMOVE EMISSION RELATED COMPONENTS.

VEHICLE EMISSION CONTROL LABEL

The emission control label is located on the left hand frame down tube on all motorcycles.

Please see the sample diagram below:

VEHICLE EMISSION CONTROL INFORMATION

Engine tune-up specification for: Irbit Motorcycle Factory, Ltd.

"IMZ" Engine Displacement 749cc; KIMFC0750Z03; KIMFPMETALU1 (Please Read Owner's Manual for Details)

Idle Speed: 900 RPM (at normal temp)

Max RPM: 6,200

Ignition Timing: Factory Preset

Idle Mixture: factory preset

Plug type: NGK BPR7HS-10

Lubricant: SAE 20W50

Plug Gap: 0.040 (1.0-1.02mm)

Fuel: 91 Octane min.

Valve Clearance (cold): 0.05-0.10 mm (.002-.004in) (exhaust and intake)

Exhaust Emission Control System: 3TWC

This vehicle conforms to all US EPA and California regulations applicable to 2022 Model Year New Motorcycles.

10. Owner's Documents

New Owner Form

New Address Form

Training Rebate Form

Intentionally left blank

Intentionally left blank



NEW ADDRESS FORM

If you move, please fill out the form and mail to the address below. This will insure that you continue to receive all correspondence from Irbit Motorworks of America.

VEHICLE IDENTIFICATION NUMBER

OWNER'S NAME _____

OLD ADDRESS _____ APT. NO. _____

CITY _____ STATE _____ ZIP CODE _____

MY NEW ADDRESS IS:

NEW ADDRESS _____ APT. NO. _____

CITY _____ STATE _____ ZIP CODE _____

Mail this form to:

Irbit Motorworks of America, Inc.
14700 NE 95th St., Suite 102
Redmond, WA 98052

Or fax to: (425) 250-6762

**We never sell or rent your personal information to third parties unaffiliated with Ural.

Intentionally left blank



URAL SIDECAR SAFETY TRAINING REBATE FORM

URAL is offering a mail-in rebate in the amount of **up to \$125** to any customer who takes a sidecar safety-training course within one year from the date of purchase of a new Ural sidecar motorcycle.

The most up to date list of safety training courses in US can be found on the Evergreen Safety Council website: <http://www.esc.org> or by calling: **1-800-521-0778**

MAIL IN:

Please detach and return (1) this completed rebate form, along with (2) a copy of Sidecar Safety-training course payment receipt and (3) certificate of course completion to:

URAL Sidecar Safety Training Rebate
14700 NE 95th Street, Suite 102
Redmond, WA 98052

Full Name (First, Last): _____

Street Address: _____

City, State & ZIP: _____

Daytime Phone: _____ **E-mail:** _____

Your Ural VIN# _____

Bike Purchase Date: _____

SUBMIT ONLINE:

GO TO: www.imz-ural.com/sidecar-safety-training

Thank You and Ride Safe!

Offer Valid with purchase of a new Ural motorcycle. Your rebate will be mailed to you within 6-8 weeks of receipt and verification. IMWA is not responsible for lost or misdirected mail. Only Sidecar Safety Training is qualified for rebate. Training must take place within 12 months of purchase of a new sidecar model Ural. Rebate not to exceed cost of the actual course or \$125; whichever is less.

Offer good only in the U.S. and void where prohibited, restricted or taxed by law.

© 2017 Irbit MotorWorks of America, Inc.

11. Schematics

Wiring Diagram

Intentionally left blank

2019 URAL Motorcycle Wire Harness

SIDECAR

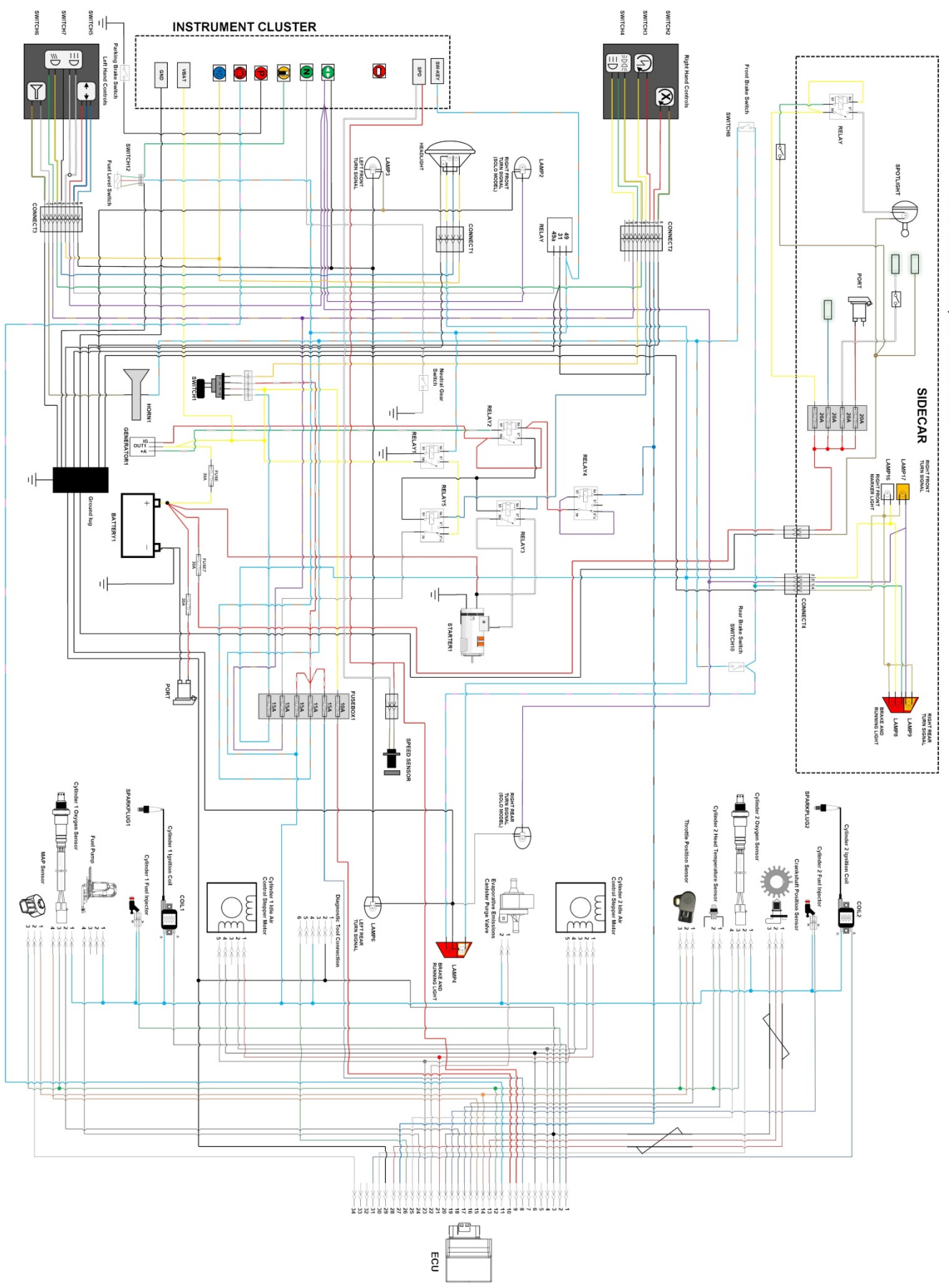



URAL MOTORCYCLES
14700 NE 95TH ST.
SUITE 102
REDMOND, WA 98052

IMZ-URAL.COM