



# **2023 OWNER'S MANUAL**

GEAR UP • CT

IMZ-URAL.COM

Intentionally left blank

## INTRODUCTION

Welcome to the URAL Motorcycling Family! Our motorcycles are assembled in Petropavlovsk, Kazakhstan and distributed by Irbit Motorworks of America, the United States affiliate of the Irbit Motorcycle Factory.

This Ural motorcycle conforms to all applicable US Federal Motor Vehicle Safety Standards and US Environmental Protection Agency regulations effective on the date of manufacture.

This manual covers the Gear-Up and cT model and has been prepared to acquaint you with the operation, care, and maintenance of your motorcycle and to provide you with important safety information. Follow these instructions carefully for maximum motorcycle performance and for your personal motorcycling safety and pleasure. It is critical that a beginning sidecar driver becomes thoroughly familiar with the special operating characteristics of the sidecar outfit before venturing out on busy roads.

Your Owner's Manual contains instructions for operation, maintenance, and minor repairs. Major repairs require the attention of a skilled mechanic and the use of special tools and equipment. Your Authorized IMWA Ural Dealer has the facilities, experience, and genuine Ural parts necessary to properly render this valuable service.

Any suggestions or comments are welcome!

*Happy Uraling!*

## **IMPORTANT SAFETY INFORMATION**

WE STRONGLY SUGGEST THAT YOU READ THIS MANUAL COMPLETELY PRIOR TO RIDING YOUR NEW URAL MOTORCYCLE. THIS MANUAL CONTAINS INFORMATION AND ADVICE THAT WILL HELP YOU PROPERLY OPERATE AND MAINTAIN YOUR MOTORCYCLE. PLEASE PAY SPECIAL ATTENTION TO NOTICES IN THIS MANUAL MARKED AS FOLLOWS:

### **CAUTION**

**INDICATES POSSIBILITY OF EQUIPMENT FAILURE THAT MAY RESULT IN YOUR MOTORCYCLE BEING UNSAFE TO OPERATE IF INSTRUCTIONS ARE NOT FOLLOWED**

### **WARNING**

**INDICATES A VERY STRONG POSSIBILITY OF INJURY TO YOURSELF AND OTHERS OR LOSS OF LIFE IF INSTRUCTIONS ARE NOT FOLLOWED**

### **NOTE**

**PROVIDES HELPFUL INFORMATION AND TIPS**



# Table of Contents

|   | Section |
|---|---------|
| General Information                     | 1       |
| Motorcycle Controls and Instrumentation | 2       |
| Motorcycle Operation                    | 3       |
| Service & Maintenance Sections          |         |
| Lubrication                             | 4       |
| Engine & Chassis Maintenance            | 5       |
| Electrical                              | 6       |
| EFI Troubleshooting                     | 7       |
| Consumer Information Sections           |         |
| Warranty Information                    | 8       |
| Emission Control Information            | 9       |
| Owner Documents                         | 10      |
| Schematics                              | 11      |

# 1. General Information

|   | Page |
|---|------|
| Service Rules                           | 1-2  |
| Model Identification                    | 1-3  |
| Model Specifications                    | 1-4  |
| Torque Chart                            | 1-5  |
| Clearance and Adjustment Specifications | 1-6  |
| Tire Data                               | 1-6  |
| Periodic Maintenance Chart              | 1-7  |
| Motorcycle Storage and Care             | 1-8  |

## SERVICE RULES

1. Always wear proper safety equipment including but not limited to safety glasses and gloves.
2. Allow your motorcycle to cool down completely prior to servicing to avoid getting burned.
3. Always use genuine Ural or Ural recommended parts, fluids and components when servicing your motorcycle. Parts that do not meet these requirements may result in damage.
4. Follow the service procedures as outlined in this manual.
5. Always follow the torque specifications when tightening nuts and bolts.
6. Clean all parts with non-flammable solvents prior to reassembly after servicing.
7. Always replace seals, O-rings, gaskets and cotter pins when reassembling.
8. If you remove self-locking nuts they should always be replaced with new ones.
9. Be responsible with solvents, cleaners and waste oils. Always dispose of them in accordance with your local regulations.

### WARNING

**IF THE ENGINE MUST BE RUNNING TO PERFORM A PARTICULAR SERVICE PROCEDURE BE SURE YOU ARE IN A WELL VENTILATED AREA. EXHAUST CONTAINS CARBON MONOXIDE GAS.**

### WARNING

**GASOLINE IS VERY FLAMMABLE AND CAN BE EXPLOSIVE UNDER CERTAIN CONDITIONS. IT IS ALSO VERY HARMFUL TO THE SKIN AND EYES. DO NOT SMOKE OR ALLOW SPARKS IN OR NEAR YOUR WORK AREA.**

## MODEL IDENTIFICATION



### VIN (Vehicle Identification Number)

The VIN label is located on the right hand frame down tube and is also stamped on the frame directly above the label.

List Your VIN Here

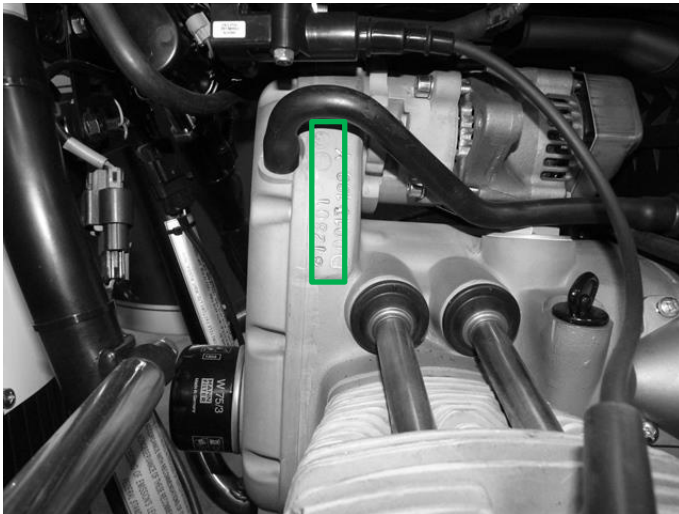

### Engine Number

The engine number is stamped near the crankcase breather. It is the second number.

List Your Engine Number Here

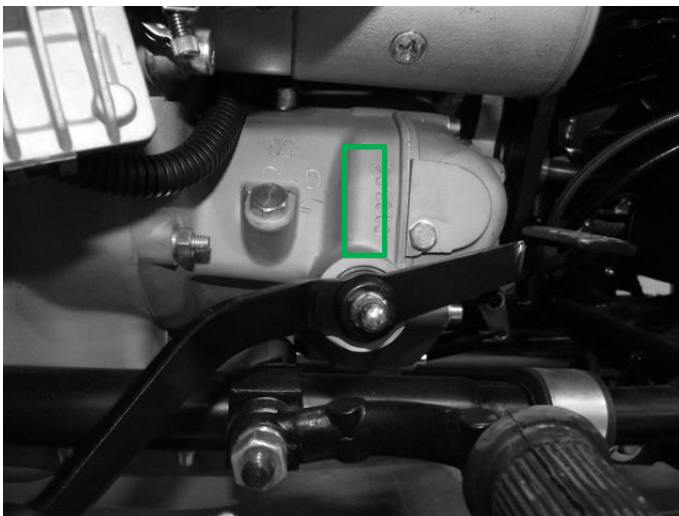

### Gearbox Number

The gearbox number is stamped on the left side of the gearbox directly above the shift lever.

List Your Gearbox Number Here

## MODEL SPECIFICATIONS

| Model                                | cT  | Gear-Up   |
|--------------------------------------|---|---|
| <b>Engine and transmission</b>       |   |   |
| Displacement, cc                     | 749   | 749   |
| Engine type                          | OHV air cooled 2 cylinder 4 stroke "boxer"<br>(flat twin)   | OHV air cooled 2 cylinder 4 stroke "boxer"<br>(flat twin)   |
| Valve per cylinder                   | 2   | 2   |
| Bore and stroke (mm x mm)            | 78 x 78   | 78 x 78   |
| Max output (hp)                      | 41 @ 5500 rpm   | 41 @ 5500 rpm   |
| Max torque (ft-lbs)                  | 42 @ 4300 rpm   | 42 @ 4300 rpm   |
| Compression                          | 10.5:1  | 10.5:1  |
| Fuel system                          | Throttle body EFI   | Throttle body EFI   |
| Starting                             | Electric & Kick start   | Electric & Kick start   |
| Clutch                               | Double-disc dry   | Double-disc dry   |
| Transmission type                    | Manual  | Manual  |
| Speeds                               | 4 forward 1 reverse   | 4 forward 1 reverse   |
| Primary drive (rear wheel)           | Driveshaft  | Driveshaft  |
| Final drive ratio                    | 4.62  | 4.62  |
| Engagable sidecar wheel drive        | No  | Yes, driveshaft   |
| <b>Physical measures</b>             |   |   |
| Overall length, inch.                | 91.6  | 98.8  |
| Overall heights, inch.               | 53.8  | 54.3  |
| Overall width, inch.                 | 63.6  | 63.6  |
| Seat height, (unladen), inch.        | 31.0  | 32.0  |
| Ground clearance (unladen), inch.    | 7.2   | 7.5   |
| Dry weight, lbs                      | 700   | 730   |
| <b>Chassis</b>                       |   |   |
| Front suspension                     | IMZ leading link fork with two Sachs hydraulic spring shock absorbers, 7x adjustable                                      | IMZ leading link fork with two Sachs hydraulic spring shock absorbers, 7x adjustable                                      |
| Rear suspension                      | Double sided swing-arm with two Sachs hydraulic spring shock absorbers, 7x adjustable                                     | Double sided swing-arm with two Sachs hydraulic spring shock absorbers, 7x adjustable                                     |
| Sidecar suspension                   | Single sided swing-arm with Sachs hydraulic spring shock absorber, 7x adjustable  | Single sided swing-arm with Sachs hydraulic spring shock absorber, 7x adjustable  |
| Wheels                               | 2.15X18 Aluminum rims with steel spokes   | 2.15X19 Aluminum rims with steel spokes   |
| Tires                                | Heidenau K28, 4.0x18"   | Heidenau K37, 4.0x19"   |
| Front brake                          | 4-piston fixed Brembo caliper with 295mm floating NG rotor  | 4-piston fixed Brembo caliper with 295mm floating NG rotor  |
| Rear brake                           | 2-piston fixed Brembo caliper with a 265mm floating NG rotor with a standalone mechanical parking brake caliper by J.Juan | 2-piston fixed Brembo caliper with a 265mm floating NG rotor with a standalone mechanical parking brake caliper by J.Juan |
| Sidecar brake                        | 2-piston fixed Brembo caliper with 245mm floating NG rotor  | 2-piston fixed Brembo caliper with 245mm floating NG rotor  |
| <b>Other</b>                         |   |   |
| Fuel grade                           | 93 (AKI) 98 (RON) Unleaded Only   | 93 (AKI) 98 (RON) Unleaded Only   |
| Fuel tank capacity (gallons)         | 5.0   | 5.0   |
| Reserve (gallons)                    | app. 1  | app. 1  |
| Estimated fuel economy, mpg          | 31-37   | 31-37   |
| Estimated range, miles               | 155-185   | 155-185   |
| Recommended max cruising speed (mph) | 70  | 70  |
| Max permissible weight, lbs          | 1325  | 1325  |
| Trunk volume, cubic ft.              | 2.9   | 2.9   |
| <b>Electrical</b>                    |   |   |
| Alternator                           | Denso, Peak Output 40 Amp @ 14vdc, 560 Wt   | Denso, Peak Output 40 Amp @ 14vdc, 560 Wt   |
| Battery                              | YTX20-BS (12V, 20A)   | YTX20-BS (12V, 20A)   |
| Headlight                            | H4 (60/55)  | H4 (60/55)  |
| Spark plugs                          | NGK BPR7HS-10   | NGK BPR7HS-10   |
| <b>Warranty</b>                      | 2-years parts and labor unlimited mileage   | 2-years parts and labor unlimited mileage   |

## TORQUE SPECIFICATIONS

| <b>Chassis</b>                                  | <b>Newton Meters</b> | <b>Foot Pounds</b> |
|---|----------------------|--------------------|
| Fork Pinch Bolts (Upper and Lower Bridges)      | 50                   | 36.9               |
| Upper fork Nuts                                 | 30                   | 22.1               |
| Steering Head Nut                               | 34                   | 25.1               |
| Front fork Upper Shock Bolts                    | 49                   | 36.1               |
| Upper Shock Bolts                               | 30                   | 22.1               |
| Lower Shock Bolts                               | 49                   | 36.1               |
| Front and Rear Brake Caliper Bracket Bolts      | 50                   | 36.9               |
| Rear Caliper Mounting Bolts                     | 50                   | 36.9               |
| Front Caliper Mounting Bolts                    | 50                   | 36.9               |
| Sidecar Caliper Mounting Bolts                  | 50                   | 36.9               |
| Front Brake Reaction Link                       | 70                   | 51.6               |
| Brake Rotors                                    | 30                   | 22.1               |
| Rear Swing Arm Mounting Bolts                   | 88                   | 64.9               |
| Sidecar Swing Arm Mounting Bolts                | 88                   | 64.9               |
| Front Fork to Pivot of Swing Arm Mounting Bolts | 50                   | 36.9               |
| Lower Sidecar Frame Mounting Bolts              | 88                   | 64.9               |
| Sidecar Strut Mounting Bolts                    | 88                   | 64.9               |
| Spoke Nipple                                    | 4 to 6               | 2.9 to 4.4         |
| <b>Drive Train</b>                              |                      |                    |
| Engine, Gearbox, and Final Drive Drain Plugs    | 22                   | 16.2               |
| Cylinder Head Nuts                              | 50                   | 36.9               |
| Valve Cover Bolts                               | 12                   | 8.8                |
| Oil Pump Drive Gear Cap Bolt                    | 10                   | 7.4                |
| Final Drive to Swing Arm Mounting Nuts          | 35                   | 25.8               |
| Final Drive Case Nuts                           | 24                   | 17.7               |
| Engine Sump                                     | 10                   | 7.4                |
| Alternator Mounting Nuts                        | 22                   | 16.2               |
| Intake Flange Mounting Bolts                    | 20                   | 14.8               |
| Exhaust Header Pipe Nuts                        | 24                   | 17.7               |
| Exhaust Mounting Clamp Bolts                    | 16                   | 11.8               |
| Drive Wheel Splines (Spline Flanges)            | 30                   | 22.1               |

## CLEARANCES

| Location                    | Millimeters | Inches |
|-----------------------------|-------------|--------|
| Intake Valves (Cold)        | .1          | .004   |
| Exhaust Valves (Cold)       | .15         | .006   |
| Spark Plug Electrode        | 1.00        | 0.04   |
| Minimum Tread Depth         | 3.175       | 0.125  |
| Minimum Brake Pad Thickness | 1           | 0.04   |

## FREE PLAY & ADJUSTMENTS

| Location          | Millimeters        | Inches             |
|-------------------|--------------------|--------------------|
| Front Brake Lever | 5 to 8             | .2 to .3           |
| Clutch Lever      | 5 to 8             | .2 to .3           |
| Rear Brake Lever  | 1/4 of Full Travel | 1/4 of Full Travel |
| Toe-In (1wd)      | 8 to 12            | .3 to .475         |
| Toe-In (2wd)      | 3 to 8             | .125 to .315       |
| Lean Out          | 1 to 2 degrees     | 1 to 2 degrees     |

## TIRE DATA

| Location            | Type   | Recommended PSI |
|---------------------|--|-----------------|
| Front               | Heidenau K38 (4.0x19) Heidenau K28 (4.0x18 cT) | 32 PSI Cold     |
| Rear                | Heidenau K38 (4.0x19) Heidenau K28 (4.0x18 cT) | 36 PSI Cold     |
| Sidecar             | Heidenau K38 (4.0x19) Heidenau K28 (4.0x18 cT) | 32 PSI Cold     |
| Spare (if equipped) | Heidenau K38 (4.0x19) Heidenau K28 (4.0x18 cT) | 36 PSI Cold     |

### WARNING

**IMPROPER TIRE INFLATION WILL CAUSE ABNORMAL TREAD WEAR AND COULD RESULT IN UNSTABLE HANDLING. UNDER-INFLATION COULD RESULT IN THE TIRE SLIPPING ON THE RIM.**

# PERIODIC MAINTENANCE CHART

| Description   | Odometer reading, miles (km) |             |               |  |              |               |               |               |
|---|------------------------------|-------------|---------------|--|--------------|---------------|---------------|---------------|
|   | New                          | 310 (500)   | 3125 (5000)   | 6250 (10000)   | 9375 (15000) | 12500 (20000) | 15625 (25000) | 18750 (30000) |
| Check the painted and chromed surfaces for dents, scratches and rust  | I                            |             |               | I  |              | I             |               | I             |
| Engine oil*   | I                            | R           | R             | R  | R            | R             | R             | R             |
| Oil filter*   |                              | R           | R             | R  | R            | R             | R             | R             |
| Final drive and gearbox oil   | I                            | R           | I             | R  | I            | R             | I             | R             |
| Check valve clearance   |                              | I           | I             | I  | I            | I             | I             | I             |
| Check tightness of the cylinder stud nuts   |                              | I           | I             | I  | I            | I             | I             | I             |
| Spark plugs   |                              | I           | I             | R  | I            | R             | I             | R             |
| Fuel pump filter  |                              |             |               |  | R            |               |               | R             |
| Check torque for final drive fastening nuts   |                              | I           | I             | I  | I            | I             | I             | I             |
| Air filter*   |                              | I           | I             | R  | I            | R             | I             | R             |
| Check fuel hoses  |                              | I           | I             | I  | I            | I             | I             | I             |
| Intake manifold gaskets (check for cracks and other damage)   |                              | I           | I             | R  | I            | R             | I             | R             |
| Throttle body synchronization   |                              | I           | I             | I  | I            | I             | I             | I             |
| Shock absorbers   |                              |             |               |  | I            |               |               | I             |
| Inspect wheels and tires (tire pressure , tire wear, rims breakage and bents, wheel balancing)*                             | I                            | I           | I             | I  | I            | I             | I             | I             |
| Tightness of spokes   |                              | I           | I             | I  | I            | I             | I             | I             |
| Tightness of fasteners  | I                            | I           | I             | I  | I            | I             | I             | I             |
| Disc brake (pads, disc, hoses, calipers and cylinders, lever travel)  |                              | I           | I             | I  | I            | I             | I             | I             |
| Brake fluid level*  |                              | I           | I             | I  | I            | I             | I             | I/R           |
| Check operations of parking brake   | I                            | I           | I             | I  | I            | I             | I             | I             |
| Front fork oil  |                              |             |               |  | R            |               |               | R             |
| Clutch, throttle cables and clutch lever travel   | I                            | I           | I             | I  | I            | I             | I             | I             |
| Bearings of the motorcycle and sidecar swing arms. 2wd linkage on 2wd models  |                              |             |               | I  |              | I             |               | I             |
| Steering head bearings  |                              |             |               | I  |              | I             |               | I             |
| Wheel bearings  |                              |             |               | I  |              | I             |               | I             |
| Sidecar alignment   | I                            |             |               |  | I            |               |               | I             |
| Battery (charge level, contacts) *  |                              | I           | I             | I  | I            | I             | I             | I             |
| Electrical equipment  | I                            | I           | I             | I  | I            | I             | I             | I             |
| Headlight position  | I                            | I           | I             | I  | I            | I             | I             | I             |
| Lubrication of lever axels, cable ends, rear brakes cams, splined parts of the drive shafts and hubs, drive shaft U-joints* |                              |             |               | I/L  |              | I/L           |               | I/L           |
| Test drive  | P                            | P           | P             | P  | P            | P             | P             | P             |
| <b>SERVICE LABOR</b>  | <b>.8hrs</b>                 | <b>2hrs</b> | <b>1.8hrs</b> | <b>3.5hrs</b>  | <b>2hrs</b>  | <b>3.5hrs</b> | <b>1.8hrs</b> | <b>4.5hrs</b> |
| I - Inspect, if necessary – adjust, clean or replace  |                              | R – Replace |               | * - Also repeat after 1 year in use and after long storage |              |               |               |               |
| L – Lubricate   |                              | P – Perform |               | ** - Also inspect when replacing tires                     |              |               |               |               |



## MOTORCYCLE STORAGE AND CARE

### Storage

If you will be storing your motorcycle for the winter or long term, take the following steps:

1. The motorcycle should be cleaned.
2. Check all fluid levels and add as necessary.
3. Check tire pressure.
4. Lubricate all shafts, splines, cables and joints.
5. Use a battery maintenance charger or disconnect battery.
6. Always store in a warm dry place to avoid rust and moisture build up.
7. Use a protective cover when needed.

After storage take the following steps prior to running your motorcycle:

1. Perform the pre-ride inspection.
2. Reconnect battery and/or disconnect charger.
3. Follow starting procedures.
4. Take the motorcycle for a short ride prior to any long trips.

### CLEANING

It is important to maintain your motorcycle properly and clean it on a regular basis. Use the following guidelines when washing your motorcycle:

- Make sure the engine is completely cool.
- Use warm soapy water and wash thoroughly.
- Avoid water entering the air filter and electrical components.
- After washing, dry the motorcycle with a cloth.
- Lubricate joints and cables as necessary.
- Run motorcycle to evaporate remaining water.

### WINTER CONSIDERATIONS

Motorists in many areas of the US experience the use of salt and other chemicals that are applied to road surfaces in the winter. Salt and other caustic chemicals should always be washed off your bike with fresh water as soon as possible to avoid rust and corrosion.

|             |
|-------------|
| <b>NOTE</b> |
|-------------|

**RUSTED OR CORRODED PARTS CAUSED BY SALT ARE NOT COVERED BY WARRANTY.**

## 2. Motorcycle Controls & Instrumentation

|                                  | Page |
|----------------------------------|------|
| Hand Controls                    | 2-2  |
| Foot Controls                    | 2-3  |
| Ignition Switch                  | 2-4  |
| Indicator Lamps                  | 2-4  |
| Speedometer Functions            | 2-5  |
| Speedometer Operation            | 2-6  |
| Parking Brake                    | 2-7  |
| Reverse Pedal                    | 2-7  |
| Kick Starter                     | 2-8  |
| 2wd Engagement Lever             | 2-8  |
| Hydraulic Spring Shock Absorbers | 2-9  |
| Hydraulic Steering Damper        | 2-9  |

## HAND CONTROLS

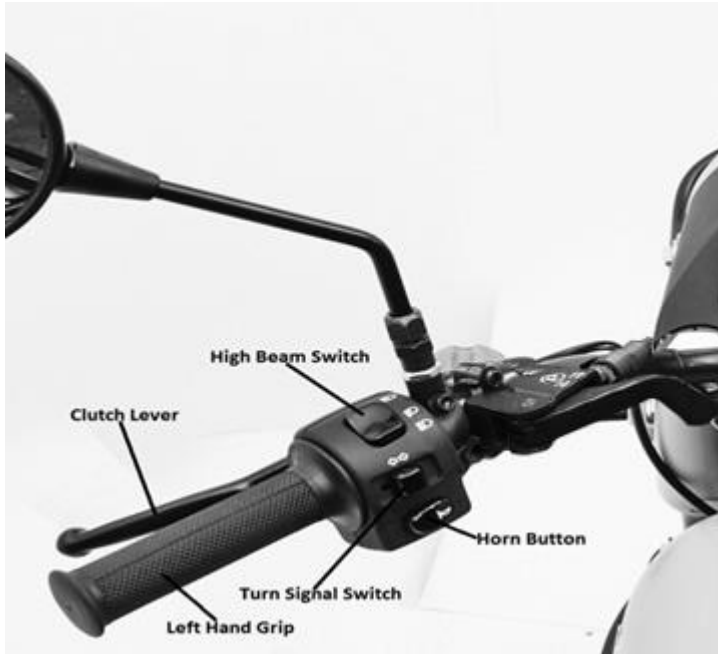

### Clutch Lever

Pulling the clutch lever will disengage the clutch while releasing the lever will engage the clutch.

### High Beam Switch

Toggle the switch forward to turn on the high beam and toggle back for “Flash to Pass” feature.

### Horn Button

Press the button to sound the horn.

### Turn Signal Switch

Switch left or right to indicate turns and push the button to cancel.

### Left Hand Grip

Place your left hand on the grip to steer and control the motorcycle.

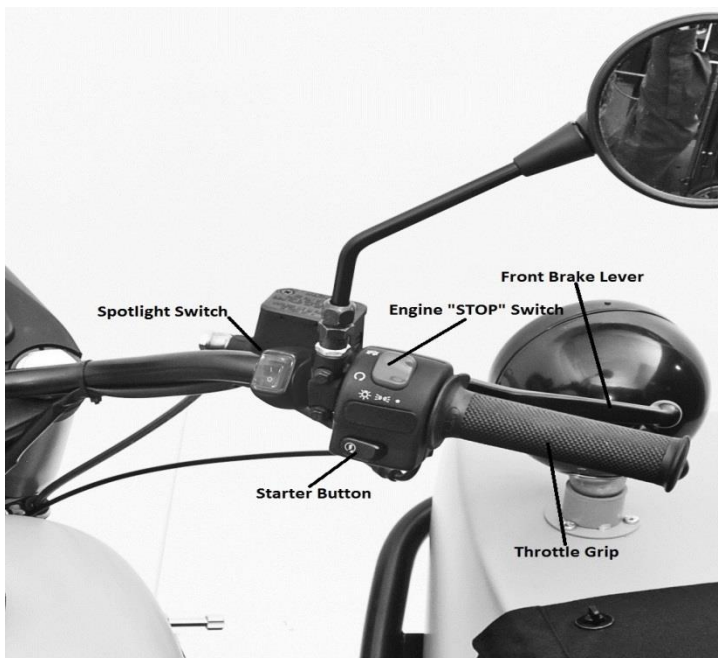

### Front Brake Lever

Pulling the lever will actuate the front brakes.

### WARNING

**IF THE BRAKE LEVER FEELS SPONGY DO NOT RIDE THE BIKE AND CONTACT YOUR DEALER.**

### Starter Button

Press the button to engage the starter motor.

### WARNING

**WHEN USING THE STARTER ALWAYS BE SURE THE GEARBOX IS IN NEUTRAL.**

### Engine “STOP” Switch

Toggle the switch forward to stop the engine. Toggle back to run.

### Throttle Grip

Place your right hand on the grip to steer and control the motorcycle. Rotate the grip back to open the throttle.

### Spotlight/Fog Light Switch (If equipped)

Toggle the switch to control the sidecar spotlight/fog light.

## FOOT CONTROLS

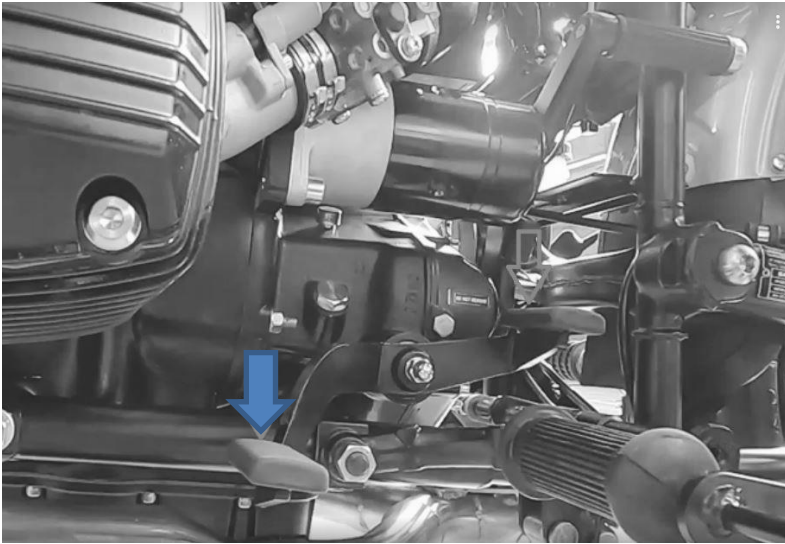

### Shift Lever

This is a heel-toe type shifter. To upshift use the heel portion of the shift lever, to down shift use the toe portion of the shifter.



### Rear Brake Lever

Pressing the rear brake lever actuates the rear and sidecar brakes.

|                |
|----------------|
| <b>WARNING</b> |
|----------------|

**IF THE BRAKE LEVER FEELS SPONGY DO NOT RIDE THE BIKE AND CONTACT YOUR DEALER.**

## IGNITION SWITCH

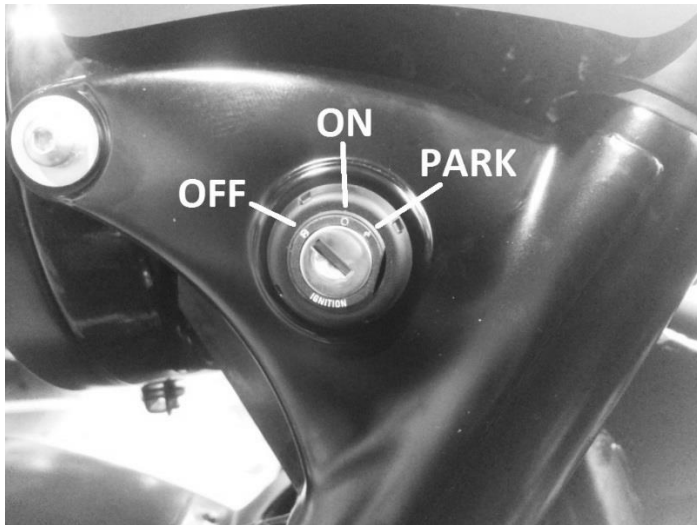

### (3 Position Switch)

In the "Off" position the engine cannot be started.

In the "On" position the engine can be started and all electrical functions can be used.

In the "Park" position only the running lamps (not including headlight) are illuminated.

## INDICATOR LAMPS



### 1. Engine "MIL" Indicator

If lamp illuminates while engine is running refer to "Troubleshooting" section of this manual.

### 2. High Beam Indicator

Lamp will illuminate when high beam is on.

### 3. Charging System Failure Indicator

Lamp will illuminate if the alternator fails.

### 4. Parking Brake Indicator

Lamp will illuminate when the parking brake is engaged.

### 5. Gearbox Neutral Indicator

Lamp will illuminate when gearbox is in neutral.

### 6. Turn Signal Indicator

Lamp flashes when signals are active.

### 7. Low Fuel Level Indicator

While on level ground lamp will flash when fuel level is low and become solid when on reserve level (approx. 1 Gal.)

### NOTE

**FUEL LAMP CAN GIVE FALSE INDICATION DUE TO SLOSHING WHILE RIDING. CHECK LAMP ON LEVEL GROUND.**

## SPEEDOMETER FUNCTIONS



### **Needle Speedometer:**

Indicates speed by analogue needle.

### **RPM: Digital Tachometer**

NOT ACTIVE

### **MAX RPM: Maximum Tachometer**

NOT ACTIVE

### **SPD: Speedometer**

Displays speed in MPH.

### **MAX SPD: Maximum Speed Meter**

Displays highest speed achieved since last reset operation.

### **AVG: Average Speed Meter**

Calculates average speed from last RESET.

### **TRIP 1 or 2: Trip Meter 1 or 2**

TRIP function accumulates trip distance since last RESET as long as bike/vehicle is moving.

### **ODO: Odometer**

ODO accumulates total distance traveled.

### **RT: Riding Timer**

1. Calculates total running time since last RESET.

2. Counter automatically begins with movement.

### **TT: Total Riding Timer**

1. Calculates total riding time from the beginning of the bike.

2. TT data is stored in memory and cannot be reset.

### **HRTT: Total Hour Meter**

1. Calculates total engine operation time.

NOT ACTIVE

### **12/24 hour Clock:**

Displays 12 or 24 hour current time.

### **Digital Voltage:**

Indicates range 8-18VDC.

### **+TRIP: Maintenance Reminder**

1. The maintenance reminder is set by trip meter and an "Off" mode to switch it off.

2. The trip meter maintenance can be set up to 9999.

## SPEEDOMETER OPERATION



### **MODE Button**

Press the MODE button to move from one function screen to another.

### **RESET Button**

Press the reset button to cycle through functions in reverse order.

### **Data Resetting**

1. Press MODE or RESET button to reach the desired screen then press RESET button for 2 seconds to reset TRIP 2, MAX SPD, MAX RPM and MAX TEMP data from stored values to zero individually. The maintenance reminder will be reset to the pre-set value.
2. The data of Trip 1, AVG & RT will all be reset at the same time when one of the 3 data functions are being reset.
3. ODO, clock, HRTT and TT data cannot be reset.

### **Data Programing**

Press both MODE & RESET buttons to go into setting mode. In setting mode, pressing the RESET button increments the flashing digit by 1 position. Press MODE button to confirm the digit setting and jump to next digit or next setting screen to be set. Press MODE button for 2 seconds on any setting screen to finish and go to normal mode.

### **12/24 Hour Clock Set-up**

Clock displays 12 or 24H in XX:XX:XX format and AM/PM when you select 12H option. Use MODE and RESET buttons as described above in **Data Programing** to finish clock setting and jump to the maintenance reminder setting or press MODE button for 2 seconds to finish and go to normal mode.

### **Maintenance Reminder Set-up**

The maintenance reminder displays a picture of a wrench and is a separate TRIP meter. You can program the maintenance trip meter for the next scheduled service interval. Use MODE and RESET buttons as described above in **Data Programing** to finish maintenance reminder setting. Press MODE button for 2 seconds to finish and go to normal mode.



## PARKING BRAKE



### Parking Brake Lever

The parking brake lever is located on the left handlebar.

Pull the handle to the left lock position to set the parking brake.

Release the parking brake by pushing the lever to the right position as shown.

### CAUTION

**OPERATING THE MOTORCYCLE WHILE THE PARKING BRAKE IS ENGAGED CAN DAMAGE THE BRAKE SYSTEM.**

## REVERSE PEDAL

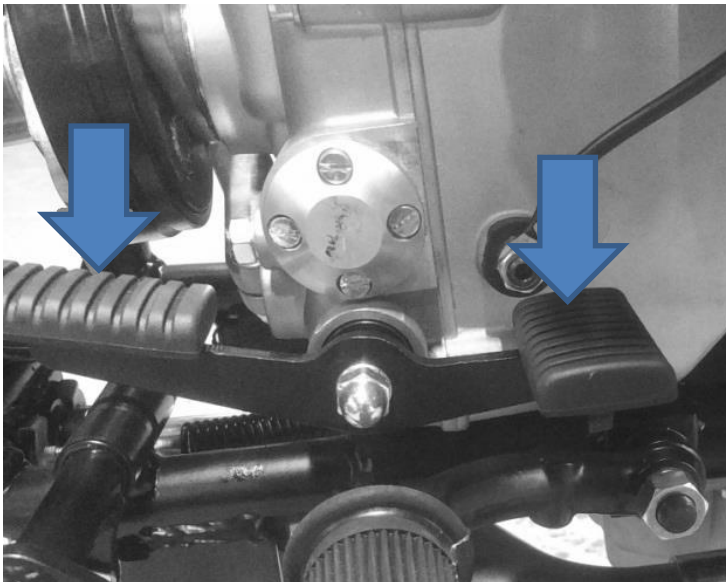

### Reverse Engagement Pedal

The reverse pedal is located on the right side of the gearbox near the foot peg.

Push the pedal back with your heel while in Neutral to engage the reverse gear.

Push the pedal forward with your toe to put the gearbox back into Neutral and use forward gears.

### CAUTION

**THE REVERSE PEDAL MUST BE IN THE FULL FORWARD POSITION FOR THE GEARBOX TO SHIFT PROPERLY.**



## KICK START LEVER

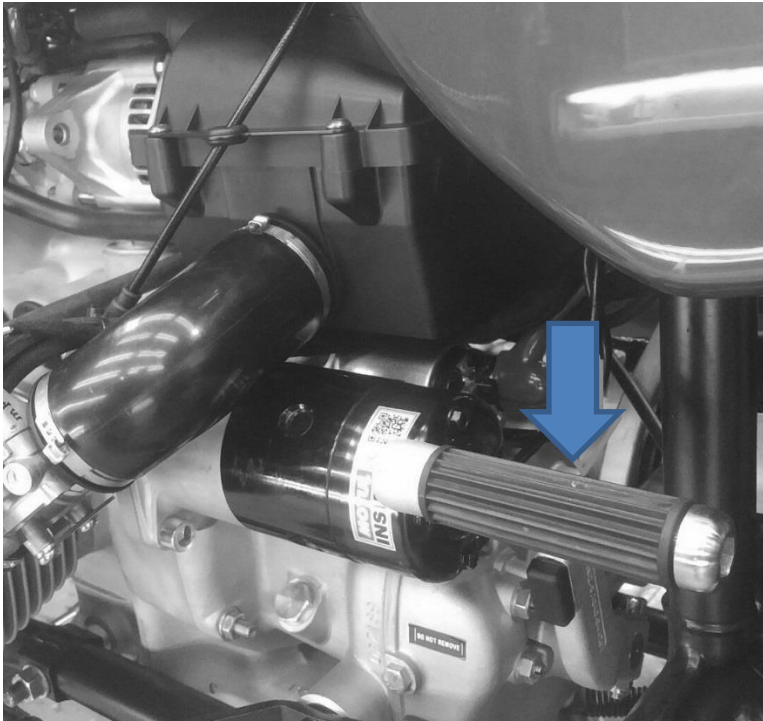

### Kick Start Lever

To use the kick start lever rapidly press the lever downward with your right foot as shown.

#### WARNING

**WHEN USING THE KICK STARTER ALWAYS BE SURE THE GEARBOX IS IN NEUTRAL.**

## 2WD ENGAGEMENT LEVER

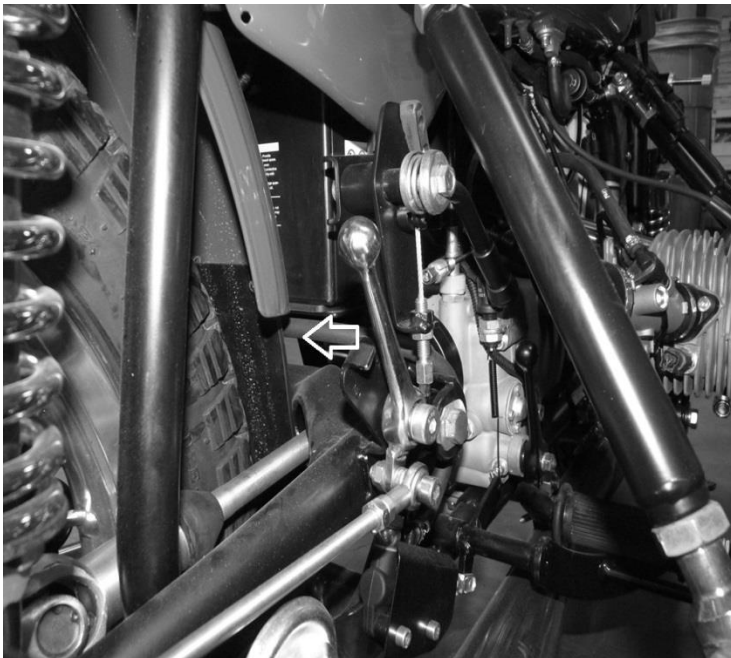

### 2wd Engagement Lever

Shift the lever into the rear locked position to engage 2wd.

Move the lever to the forward position to dis-engage 2wd.

#### CAUTION

**2WD SHOULD ONLY BE USED FOR LOOSE ROAD CONDITIONS AND/OR OFF ROAD PURPOSES.**

#### WARNING

**USE OF 2WD ON THE STREET CAN MAKE THE MOTORCYCLE DIFFICULT TO STEER, POSSIBLY RESULTING IN LOSS OF CONTROL.**

## HYDRAULIC SPRING SHOCK ABSORBERS



### Adjustable Shock Absorbers

The shock absorbers have 5 preload adjustments.

Rotate the adjustment ring counter clockwise as shown to increase spring preload using the supplied wrench in your tool kit.

## HYDRAULIC STEERING DAMPER



### Adjustable Damper (16 Position)

The steering damper is fully adjustable to accommodate different riding styles and conditions.

Rotate the adjustment rod clockwise to increase dampening and counterclockwise to reduce dampening.

### CAUTION

OVER ROTATION OF THE ADJUSTMENT ROD CAN DAMAGE THE DAMPER AND/OR CAUSE FLUID LEAKS.

## 3. Motorcycle Operation

|                            | Page |
|----------------------------|------|
| Pre-ride Inspections       | 3-2  |
| Initial Ride Instructions  | 3-2  |
| Sidecar Safety             | 3-3  |
| Starting Procedures        | 3-5  |
| Run-In                     | 3-6  |
| Motorcycle Use and Loading | 3-6  |

## **PRE-RIDE INSPECTIONS**

Prior to each ride you should inspect the motorcycle's technical condition for safety. Use the following pre-ride inspection list to ensure your motorcycle is safe and ready to ride.

1. Check the oil level. Low oil level causes premature wear and possible engine damage.
2. Check the fuel level.
3. Check the tire pressure. Low tire pressure can cause poor handling. Also inspect the tire for abnormal and/or excessive wear that may lead to a flat tire.
4. Check all lights for proper operation including headlight, running lights, turn signals, and brake lights.
5. Check the brakes for proper operation and correct fluid level. If for any reason the brakes feel abnormal or spongy do not ride the bike as it may be unsafe.
6. Inspect all cables to insure they are not pinched or routed improperly; also inspect the clutch cable for correct free play.
7. Check for any loose fasteners and tighten as necessary.
8. Be sure any luggage is secured before riding.

## **INSTRUCTIONS FOR INITIAL RIDE**

The following steps should be taken prior to and during your first ride:

1. Read the entire owner's manual prior to starting and/or taking your first ride.
2. Familiarize yourself with all controls and instruments.
3. Make any required adjustments to mirrors and controls for comfort.
4. Always wear safety gear including but not limited to: helmet, boots, gloves, and jacket regardless of weather.
5. Ride in a safe environment such as a parking lot or area you are familiar with while you learn the specific handling characteristics of your new sidecar motorcycle.
6. Follow the "Engine Run-in" instructions.

## SIDECAR SAFETY

The Ural sidecar motorcycle, since it has three wheels, behaves quite differently from either a solo motorcycle or a car. For these reasons the following label has been attached to your motorcycle tank:

***WARNING: LEFT-HAND AND RIGHT-HAND TURNS MAY BE DANGEROUS. EXCESSIVE SPEED AND AN UNWEIGHTED SIDECAR MUST BE AVOIDED.***

Like any other motor vehicle, if the Ural is driven beyond its design limits, you can get hurt. Properly driven, since you have the added stability of the third wheel in case of sand, ice or slippery road conditions, the Ural will give you a much safer ride than a solo motorcycle in adverse conditions.

If possible, an experienced sidecar driver (preferably your Authorized Ural dealer) should ride along during your first ride. If not, put about 100 LB of ballast in the sidecar during your initial training. Although an experienced driver can safely drive the Ural with an empty sidecar, a beginner should always have ballast or a passenger in the chair.

Check with your local IMWA Dealer to find out your particular state's sidecar driver's license requirements.

When you accelerate, the Ural will pull slightly to the right due to the inertia and drag of the side car.

When you let off the gas it will pull slightly to the left due to the inertia of the sidecar.

Practice starting and stopping from various speeds, shifting up and down, accelerating and decelerating in each gear, turning right and left at slow-to-medium speeds.

|                |
|----------------|
| <b>WARNING</b> |
|----------------|

|   |
|---|
| <b>THE GEAR-UP WITH ENGAGEABLE SIDECAR WHEEL HANDLES DIFFERENTLY WITH THE SIDECAR DRIVESHAFT ENGAGED AND CANNOT TURN ON PAVED ROADS. FOR THIS REASON, THE SIDECAR DRIVE MUST ONLY BE ENGAGED WHEN OPERATING THE VEHICLE OFF-ROAD OR WHERE SNOW, ICE AND MUD CONDITIONS ARE ENCOUNTERED ON ROAD.</b> |
|---|

### **SIDECAR SAFETY (CONT.)**

Finally, practice lifting the sidecar. To do this drive in a clockwise circle about 20 feet in diameter. Gradually increase your speed until the sidecar wheel lifts from the surface 6 - 12 inches. Then roll off the throttle and ease steering pressure on the grips so it gradually comes back down. Repeat doing this until you feel comfortable with the wheel in the air. Remember, the moment you roll off the throttle it will come down. When you have mastered “flying the chair” to the point where you can keep it in the air for a full circle you will have a good feel for the speed and turn radius that will lift the sidecar.

If, after gaining proficiency with the Ural, you plan to drive on the street with an empty sidecar, go back to the parking lot and practice the above maneuvers with an empty sidecar. You’ll find that the sidecar will lift much more readily when it is empty, especially if you enter a decreasing radius turn (such as a freeway off ramp) at too high a speed. This is why we recommend generally carrying about 100 lbs. or more in the sidecar.

|                |
|----------------|
| <b>WARNING</b> |
|----------------|

**BALLAST WEIGHT SHOULD ALWAYS BE PROPERLY SECURED IN THE SIDECAR AND CENTERED FOR BEST BALANCE.**

## **STARTING THE ENGINE WHEN COLD**

Use the following instructions when starting a cold engine:

1. Check that you have enough fuel.
2. Switch ignition on.
3. Be sure the transmission is in neutral.
4. Switch the kill switch to run.
5. Press the starter button or use the kick starter until engine starts.
6. Allow engine to warm for a few moments prior to riding.

### **NOTE**

**ENGINE CRANKING SPEED CAN BE REDUCED IN COLD WEATHER, FOLLOW THE RECOMMENDATIONS FOR PROPER OIL WEIGHT FOUND ON PAGE 4-2.**

### **CAUTION**

**DO NOT ACCELERATE WHILE STARTING THE BIKE! DO NOT RUN STARTER FOR MORE THAN 5 SECONDS. NEVER STAND IN FRONT OF THE MOTORCYCLE WHILE THE ENGINE IS RUNNING.**

## **STARTING THE ENGINE WHEN WARM OR HOT**

Use the following instructions when starting a warm or hot engine:

1. Check that you have enough fuel.
2. Switch ignition on.
3. Be sure the transmission is in neutral.
4. Switch the kill switch to run.
5. Press the starter button or use the kick starter until engine starts.

### **CAUTION**

**DO NOT ACCELERATE WHILE STARTING THE BIKE! DO NOT RUN STARTER FOR MORE THAN 5 SECONDS. NEVER STAND IN FRONT OF THE MOTORCYCLE WHILE THE ENGINE IS RUNNING.**

## **ENGINE RUN-IN**

During the first 600 miles it is important not to overload or over rev the engine while riding. To ensure proper break-in you should ride the motorcycle conservatively at varying speeds and loads. Use the following guidelines during the first 600 miles prior to the initial break-in service:

1. Do not overload or “lug” the engine.
2. Do not exceed a top speed beyond 60mph.
3. Do not ride at a constant rpm for long periods of time.
4. Try to vary speed and load when riding.
5. Shift smoothly between gears and do not down shift at high rpm.
6. Always be sure the engine is warmed up before riding.
7. Follow the pre-ride inspection.

## **MOTORCYCLE USE AND LOADING**

Here are few things to consider for the best experience while planning and preparing your sidecar outfit for a trip. Remember, sidecars and their handling characteristics differ from their two wheeled counterparts.

**Air cooled** - Heat is detrimental to air cooled engines. When planning for a ride, consider a few factors before choosing your route.

- **What is the ambient temperature?**
- **Will I have a passenger or additional payload?**
- **What is the best route for the speed I will be able to maintain?**

**External Temperature** – Keep in mind how maintaining high rates of speed or carrying additional cargo can affect the temperature of the motor. Planning ahead while riding in warmer temperatures or with added payload will lessen the likelihood of encountering an unexpected change of plans.

**High Speed** – Urals are geared and tuned for off road use while providing the capability of long-distance travel. The ability to do both restricts maximum speed. Maintaining max speeds all day can be taxing on the drivetrain. Plan ahead to arrive on time to your destination.



- **Rider, no passenger or payload: 65-70 mph.**
- **Rider and passenger, no payload: 60-65 mph.**
- **Rider, Passenger and payload up to max GVW 50-60 mph.**

***Ural recommends a maximum speed of 70 mph.*** - The recommended max speed is not intended to be maintained for long periods of time. Reduce maintained max speed accordingly as temperatures rise throughout the day and/or if you will be traveling long distances with additional payload.

- **Reduce max speed for heavy payloads and as ambient temperatures rise.**
- **Allow the motor to cool at fill-ups. Take a break before resuming on a long trip.**
- **Give your Ural 20 minutes to cool for every 2 hours of use.**

**Long Distance** - Ural motorcycles are very capable of long distances if routine maintenance, rate of speed and the load are adjusted accordingly based on the conditions.

- **If traveling in warm temperatures, reduce speed and/or make periodic cooldown stops.**
- **Make it a habit on longer trips to check oil at fill-ups and cooldown/rest stops. High temperatures and sustained speed can lead to higher level of oil consumption.**

**Off Road** - Off road riding includes but is not limited to fire roads, desert trails, snow covered, obstructed, rutted, pot holed, rock covered paths, quarries, beaches, mud holes, etc. or any environment where speed, weight, traction, temperature extremes and other elements effect operation and/or navigation and the demands of the motorcycle beyond that of normal on highway use.

- **Do not ride beyond your skill level or the abilities of the motorcycle.**
- **Do not embark on unknown routes without proper resources to assist you in the event that an unforeseen circumstance does arise.**

If you choose to use your sidecar outfit in the manner outlined above, expect that maintenance and/or repairs **will be** required in addition to the regular service intervals.

Items often requiring inspection, service and/or repair after aggressive off road riding include but is not limited to:

- **Nuts, bolts, screws and other retaining fasteners that may have loosened or been lost due to vibration.**
- **Tires, tubes, spokes, wheel rims, shocks, steering damper, steering head bearings and swing arm pivot points.**
- **Clutch wear, cable stretch, brake pad wear, electrical connections and lighting.**

**Load** - The max permissible weight should be considered when planning a trip, choosing a route and while loading the outfit. Use common sense, particularly if you're planning to go off road.

- **Shock preload should be appropriate for the terrain and payload.**
- **Tire pressure should be in accordance with the specifications in the owner's manual.**
- **Clutch cable free play should be to specification to avoid excessive clutch slippage while navigating rough roads, loose sand or gravel, mud, etc.**
- **Being overloaded on the road and particularly over continuous rough terrain will deteriorate the sidecar bodies' rubber suspension faster than normal.**
- **When loaded and off road navigate obstacles slowly and cautiously, reduce speed over rough terrain.**

### **Recommend Max Additional Payloads**

-----

#### **Gear-Up**

590lb Max Additional Payload

#### **M70/Retro**

430lb Max Additional Payload

#### **cT**

440lb Max Additional Payload

-----

**Wind Drag & Load Equalization** – Two elements often overlooked are wind drag and payload balancing.

Maximum cruising speeds should be reduced from the recommended maximum for sidecar outfits with windscreens that increase wind drag. This can create excessive heat leading to premature fatigue of vital components and possibly increase oil consumption.

Avoid “piling on” cargo in any location of the outfit that will act as a sail, increase wind drag and increase strain on the drive train. Unbalanced loads will change the handling characteristics in turns, while cornering and while braking. Optimize loading of cargo for better handling and safer operation.

### Sidecar Loading Balance Percentage

---

**Trunk area = 20%, Passenger Area = 70%, Front of Sidecar = 10%**

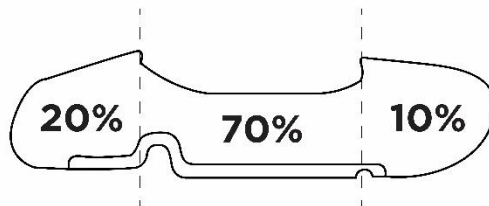

---

**Accessory Location Do's and Don'ts** – In addition to payload effects on handling and heat generating strain on the drivetrain, consider where accessories are to be mounted to maximize handling and safety.

- **Do mount factory authorized accessories with common sense in logical locations that avoid weakening substrates or anywhere that would jeopardize chassis integrity.**
- **Don't mount accessories in areas that will affect driver control, inhibit or limit steering function, pull throttle cables, limit brake pedal accessibility, etc.**
- **Don't mount Jerry cans or other hazardous items to the front area of the sidecar or anywhere an impact is more likely to create a safety hazard.**

**Know Your Motorcycle** – Be a conscientious rider and use your senses to alert you to potential changes in the performance of the drivetrain; sight, sound, smell, and feel.

- **Look at your dipstick, has oil consumption increased? The engine can use 16-26 milliliters of oil every 100 miles depending on riding conditions.**
- **Do you hear anything out of the ordinary? Are the brakes squeaking? A good running Ural has been compared to a sewing machine. If the pitch of the engine has changed or valve train is making excessive noise this could be a sign to take a break and let the engine cool. If the sound continues, further diagnosis will be required.**
- **Do you smell burnt oil, smoking clutch, rubber, gas? Any smell that stands out while riding or while stopped should be investigated to determine the source and assess the situation.**
- **Have you felt a loss of power, a shudder while stopping or maybe the brake lever feels different? Any changes that cannot be attributed to road conditions, wind, etc. should be investigated as soon as is safe to do so.**

**Know your warranty** - Know the limits of your warranty coverage as outlined in the owner's manual.

- **Purchase a roadside assistance program in addition to or separate from your insurance to cover unexpected towing expenses should they arise.**
- **Are Ural dealers or service centers available along the chosen route? If not Ural shops are there repair facilities that can handle tire changes, oil changes, etc.**

**For longer trips carry Ural specific spares for wear items not covered by warranty like, oil filters, brake pads, u-joints, etc.**

## 4. Lubrication

|   | Page |
|---|------|
| Recommended Fluids, Lubricants & Capacities | 4-2  |
| Lubrication Diagram                         | 4-3  |
| Lubrication Points                          | 4-4  |
| Engine oil and filter replacement           | 4-5  |
| Gearbox oil replacement                     | 4-7  |
| Final drive oil replacement                 | 4-8  |
| Drive Shaft Lubrication                     | 4-9  |
| Cable Lubrication                           | 4-10 |

## FLUIDS, LUBRICANTS & CAPACITIES

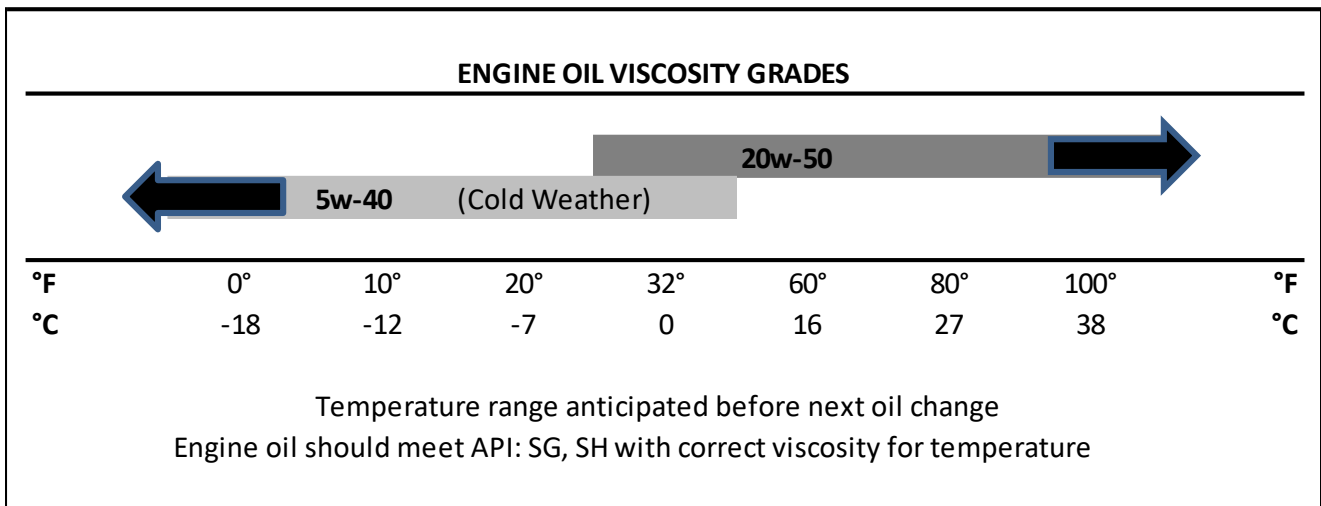

| Location                             | Capacity           | Type                  |
|--------------------------------------|--------------------|-----------------------|
| Engine (with Filter Change)          | 2.6 l              | Motul 3000 4T 20w50   |
| Gearbox                              | 0.9 l              | Motul Twin SAE 75W90  |
| Final Drive 2wd                      | 115ml              | Motul Twin SAE 75w90  |
| Final Drive 1wd                      | 90ml               | Motul Twin SAE 75W90  |
| Front Brake Reservoir                | 20 cm <sup>3</sup> | Motul DOT 4           |
| Rear Brake Reservoir                 | 15 cm <sup>3</sup> | Motul DOT 4           |
| Sidecar Brake Reservoir              | 30 cm <sup>3</sup> | Motul DOT 4           |
| Drive Shaft Joints                   | N/A                | Motul Tech Grease 300 |
| Drive Shaft Spines                   | N/A                | Motul Moly Grease     |
| Clutch Shaft Splines                 | N/A                | Motul Moly Grease     |
| Drive Wheel Splines (Spline Flanges) | N/A                | Motul Moly Grease     |
| Wheel Axles                          | N/A                | Motul Tech Grease 300 |
| Brake Linkage and Pivots             | N/A                | Motul Tech Grease 300 |
| Cables                               | N/A                | Motul E.Z. Lube       |

### NOTE

**URAL MOTORCYCLES EXCLUSIVELY USES MOTUL FLUIDS AND LUBRICANTS DURING INITIAL ASSEMBLY. URAL MOTORCYCLES RECOMMENDS MOTUL FLUIDS AND LUBRICANTS FOR ALL SERVICE INTERVALS.**

# LUBRICATION DIAGRAM

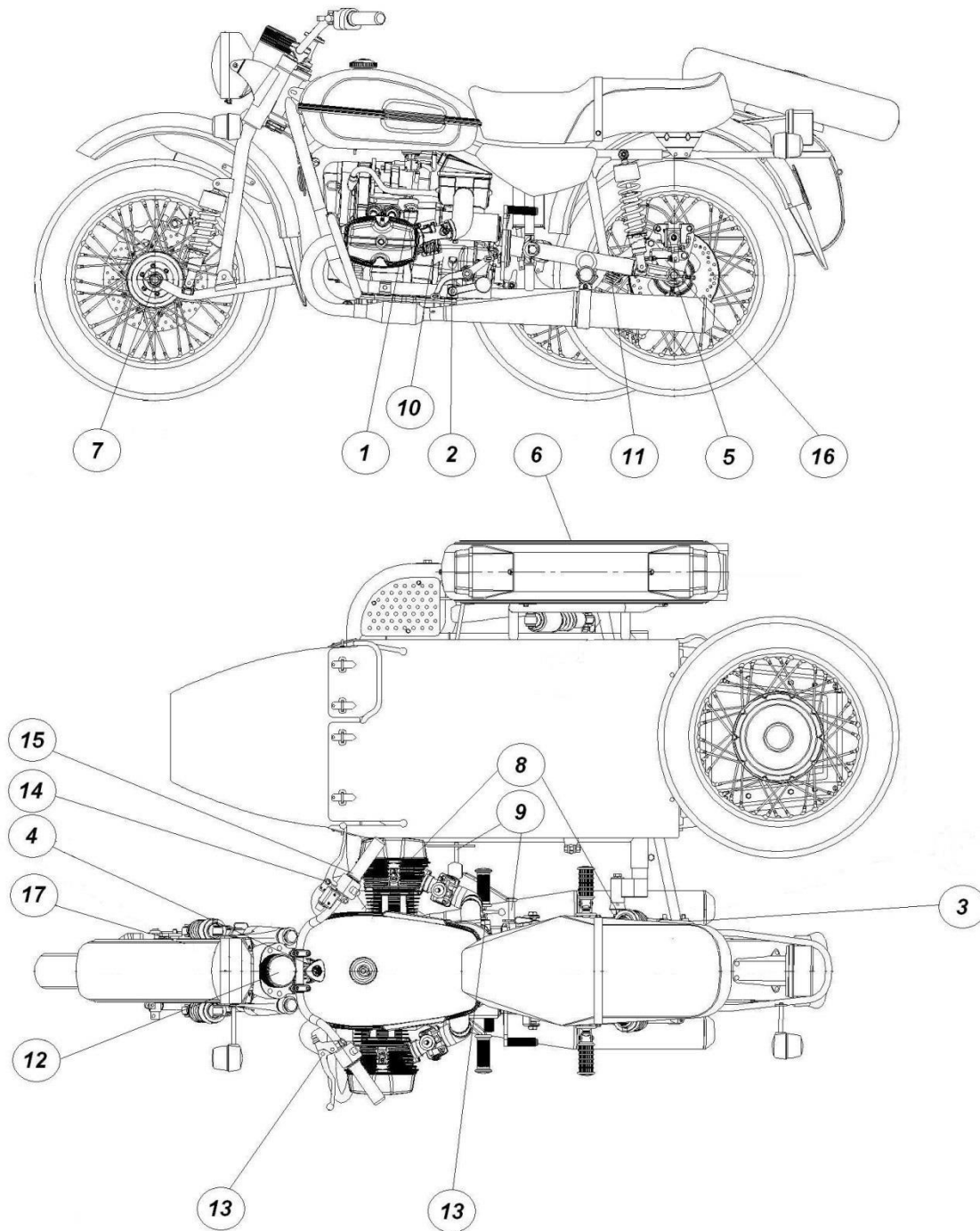

## LUBRICATION POINTS

| Diagram Position | Location                          | Type                  |
|------------------|-----------------------------------|-----------------------|
| 1                | Engine Oil Fill                   | Motul 3000 4T 20w50   |
| 2                | Gearbox Oil Fill                  | Motul Twin SAE 75W90  |
| 3                | Final Drive Oil Fill              | Motul Twin SAE 75W90  |
| 4                | Steering Head Bearing             | Motul Tech Grease 300 |
| 5                | Final Drive Output Spines         | Motul Moly Grease     |
| 6                | Sidecar Drive Shaft Splines (2wd) | Motul Moly Grease     |
| 7                | Axles                             | Motul Tech Grease 300 |
| 8                | Sidecar Mounting Pivots           | Motul Tech Grease 300 |
| 9                | Sidecar Brake Linkage Bushing     | Motul Tech Grease 300 |
| 10               | Clutch Shaft Splines              | Motul Moly Grease     |
| 11               | Drive Shaft U-Joints              | Motul Tech Grease 300 |
| 12               | Speedometer Cable                 | Motul E.Z. Lube       |
| 13               | Clutch Cable                      | Motul E.Z. Lube       |
| 14               | Front Brake Lever Pivot Bolt      | Motul Tech Grease 300 |
| 15               | Throttle Cables                   | Motul E.Z. Lube       |
| 16               | Parking Brake Cables              | Motul E.Z. Lube       |
| 17               | Front Brake Mount Axle Bushings   | Motul Tech Grease 300 |



## ENGINE OIL & FILTER REPLACEMENT



### Step 1

Place a drain pan under the oil sump and remove the drain plug using a 17mm socket wrench.



### Step 2

With the drain pan in place remove the oil filter.

#### NOTE

AN OIL FILTER WRENCH MAY BE REQUIRED FOR REMOVAL

#### CAUTION

BE SURE TO REMOVE THE OIL FILTER SEALING RING FROM THE ENGINE COVER TO AVOID OIL LEAKS

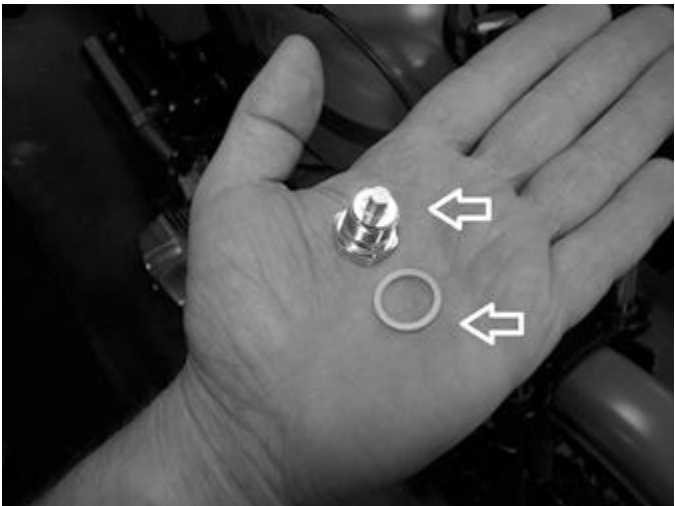

### Step 3

Be sure to clean any metal contaminants from the drain plug and replace the drain plug sealing washer.

### Step 4

Re-install drain plug and washer and torque to specification.

## ENGINE OIL & FILTER REPLACEMENT (CONT.)



### Step 5

Lightly lubricate the new oil filter sealing ring with fresh oil and install filter tightening approximately  $\frac{1}{4}$  turn after seat of seal.

### CAUTION

**DO NOT OVER-TIGHTEN THE OIL FILTER**



### Step 6

Fill engine with 2.6L of recommended motor oil

### Step 7

Start the engine and let run for 30 seconds, confirming you have no oil leaks at filter.

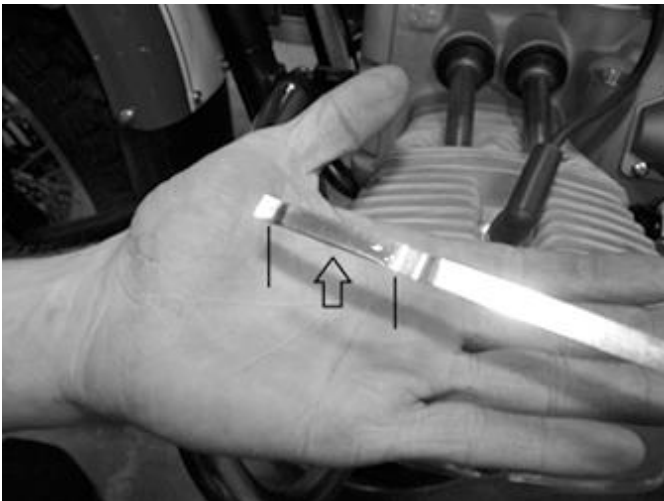

### Step 8

Check oil level, oil should be full to the upper mark on the dipstick, add oil as needed.

### NOTE

**ALWAYS DISPOSE OF MOTOR OIL PROPERLY**

## GEARBOX OIL REPLACEMENT



### Step 1

Place a drain pan under the gearbox and remove drain plug using a 17mm socket wrench.

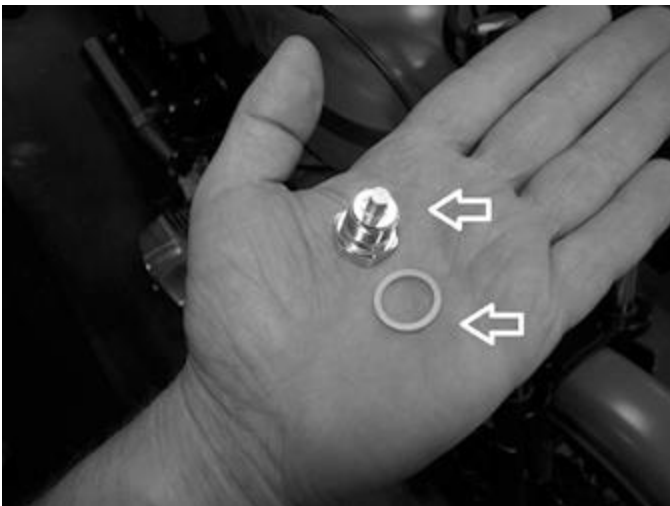

### Step 2

Be sure to clean any metal contaminants from the drain plug and replace the drain plug sealing washer.

### Step 3

Re-install drain plug and washer and torque to specification.

### Step 4

Fill the gearbox with .9L of recommended gear oil.



### Step 5

Re-install fill plug and torque to specification.

|             |
|-------------|
| <b>NOTE</b> |
|-------------|

**ALWAYS DISPOSE OF MOTOR OIL PROPERLY**



## FINAL DRIVE OIL REPLACEMENT

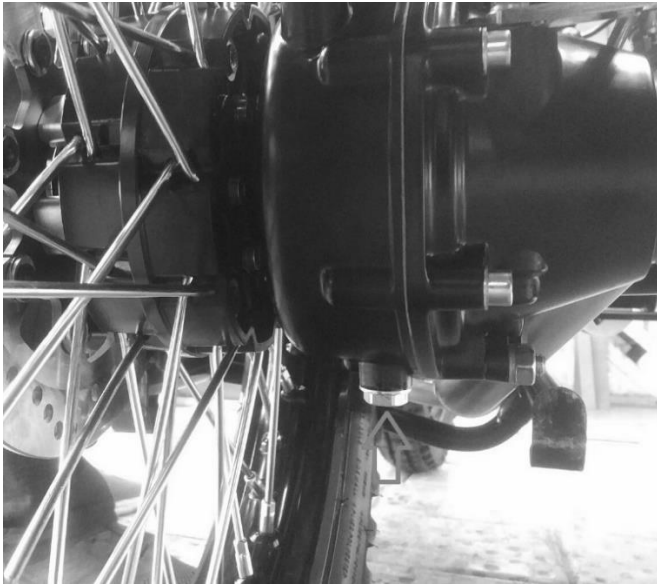

### Step 1

Place a drain pan under the final drive and remove the drain plug using a 17mm socket wrench.

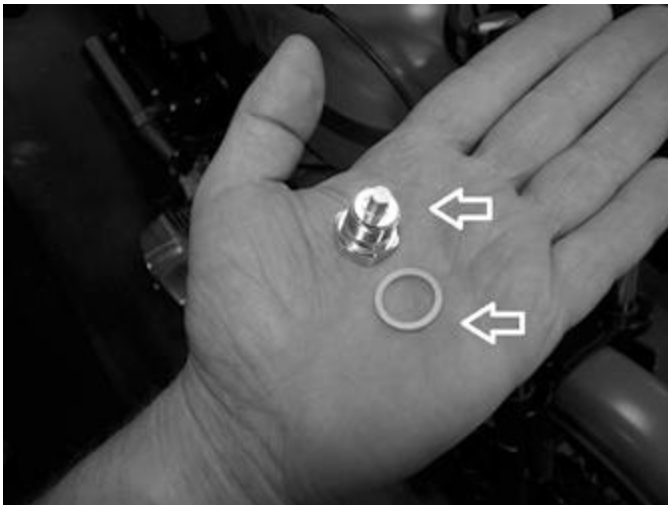

### Step 2

Be sure to clean any metal contaminants from the drain plug and replace the drain plug sealing washer.

### Step 3

Re-install drain plug and washer and torque to specification.

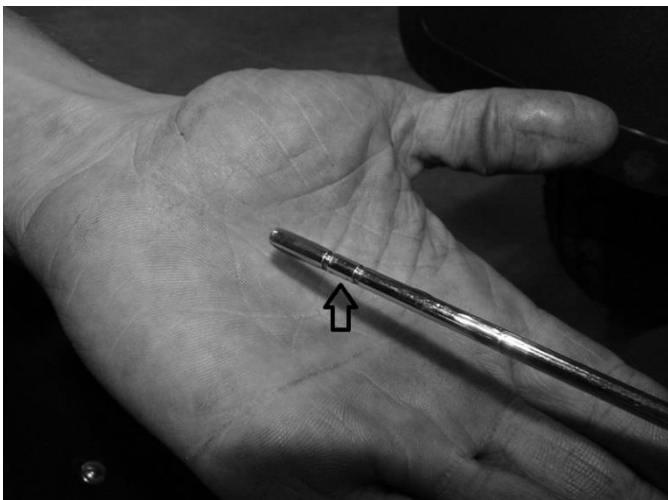

### Step 4

Fill the final drive with 115ml (2wd) or 90ml (1wd) of recommend gear oil.

### Step 6

Check oil level by threading the dipstick into the case. Oil should be full to the upper mark. Add fluid as needed.

|             |
|-------------|
| <b>NOTE</b> |
|-------------|

**ALWAYS DISPOSE OF GEAR OIL PROPERLY**

## DRIVE SHAFT & SPLINE LUBRICATION



### Final Drive Shaft

U-Joints should be lubricated with grease using a grease gun.

The rear drive shaft has one grease zerk located at the u-joint; grease this joint per the maintenance intervals or after off road use.

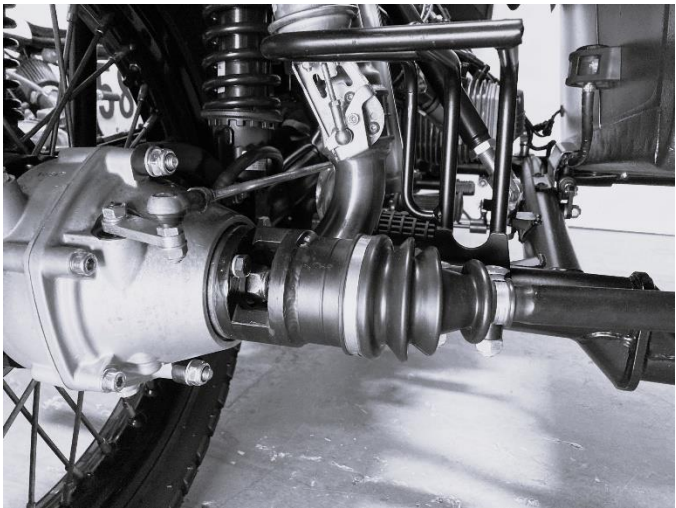

### Sidecar Drive Shaft

The 2wd sidecar CV driveshaft is maintenance free and does not require lubrication. The CV driveshaft boots should be regularly inspected for cracks, loose clamps and/or loss of grease to ensure the CV joint remains lubricated and free of moisture and/or debris.

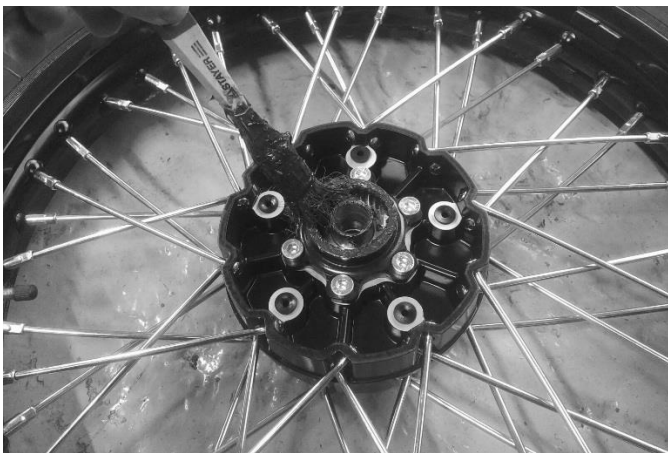

### Drive Wheel Splines

The rear wheel drive splines should be greased per the maintenance intervals or after off road use.

2wd models also have drive splines located on the sidecar wheel; splines should be greased per the maintenance intervals or after off road use.



## CABLE LUBRICATION

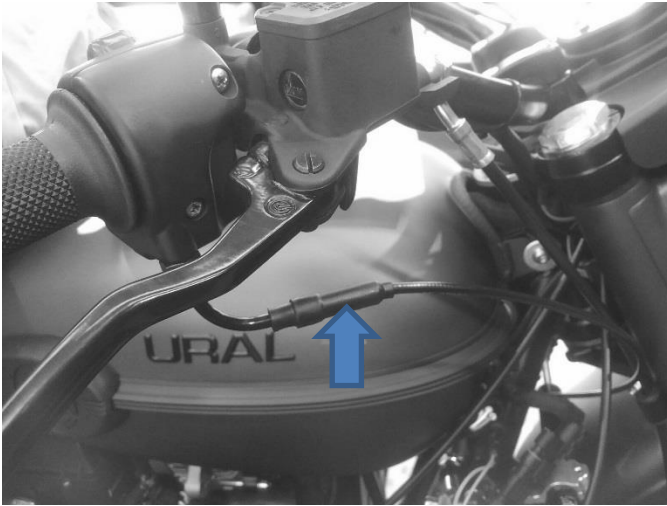

All cables including the clutch, speedometer, throttle, and parking brake cables should be lubricated with Motul E.Z. Lube per the maintenance intervals. You should also lubricate all cables before and after extended periods of storage and/or after off road use.

To lubricate the cables, pull back the protective covers and apply lube directly to the cable as shown. You can also use cable lubrication tools available by aftermarket companies.

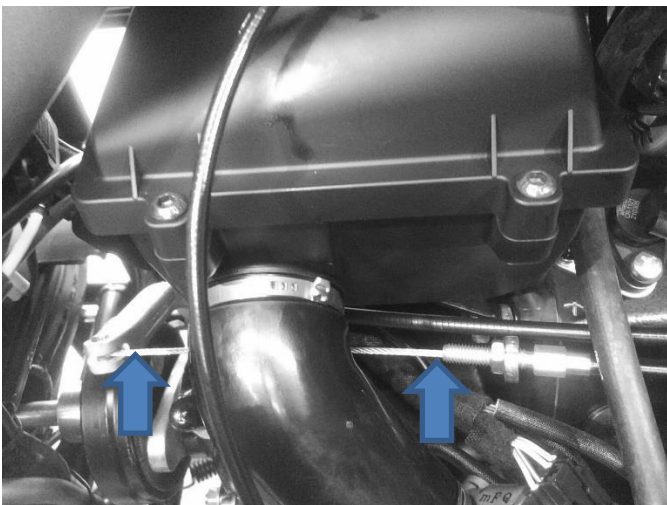

## 5. Engine & Chassis Maintenance

|                                      | Page |
|--------------------------------------|------|
| Air filter Inspection & Replacement  | 5-2  |
| Valve Train Inspection & Adjustment  | 5-3  |
| Front Brake System Maintenance       | 5-5  |
| Rear Brake System Maintenance        | 5-7  |
| Parking Brake Adjustment             | 5-9  |
| Sidecar Brake System Maintenance     | 5-10 |
| Wheel Removal & Installation         | 5-12 |
| Using the Spare Wheel                | 5-20 |
| Spoke Maintenance                    | 5-20 |
| Wheel Bearing Replacement & Diagrams | 5-21 |
| Tire & Tube Replacement              | 5-22 |
| Sidecar Alignment                    | 5-23 |
| Sidecar Alignment Diagram            | 5-24 |

## AIR FILTER INSPECTION & REPLACEMENT



### Step 1

Remove the four retaining bolts from the air box lid using a 5mm hex wrench.



### Step 2

Carefully remove the air box lid by lifting the right side and sliding the lid to the left. Be very careful not to pull wiring and cables near the air box inlet.

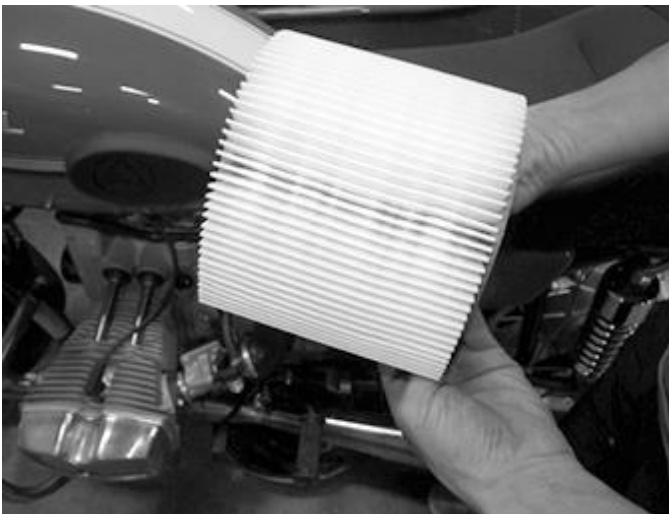

### Step 3

Remove the paper filter element from the housing and inspect for debris. The filter should be replaced per the maintenance intervals and/or as need during inspections.

### Step 4

Re-install the filter in reverse order. Be sure the replacement filter is fully seated in the air box housing and the lid is properly installed prior to tightening the retaining bolts.

### CAUTION

**A DIRTY OR CLOGGED AIR FILTER CAN REDUCE THE PERFORMANCE OF YOUR ENGINE AND POSSIBLY DAMAGE INTERNAL ENGINE PARTS.**



## VALVE TRAIN INSPECTION & ADJUSTMENT

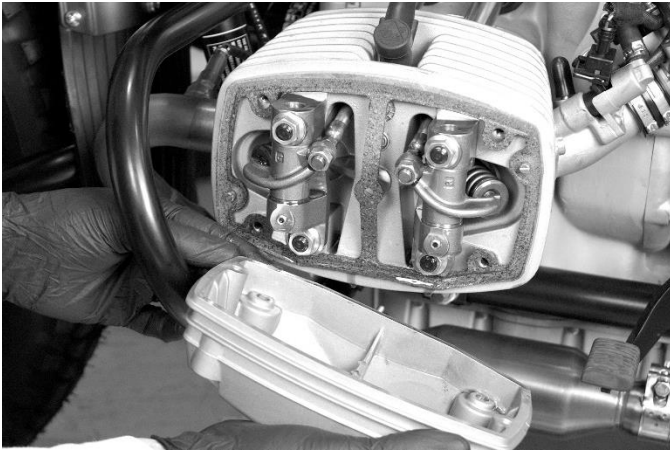

### Step 1

Starting with the left side cylinder, remove the valve cover and clean any contaminants found inside with a shop towel.



### Step 2

Remove the timing plug located on the right side of the engine case. Slowly rotate the engine using the kick start lever until both valves are closed and the TDC (top dead center) mark located on the flywheel is centered in the window.

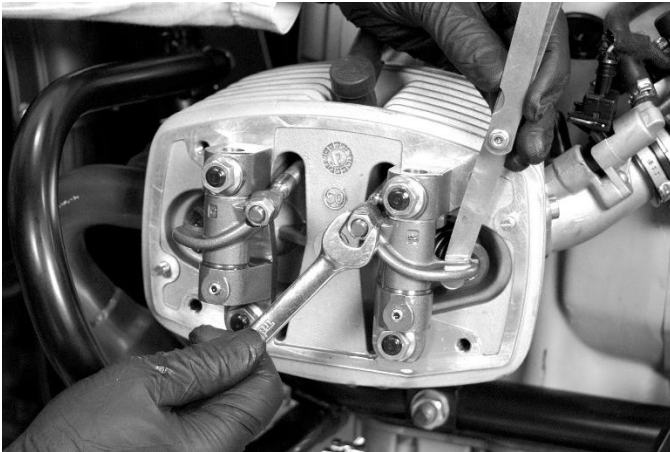

### Step 3

Using a feeler gauge, check the free play on both valves to confirm they are within specifications.

## VALVE TRAIN INSPECTION & ADJUSTMENT (CONT.)



### Step 4

If the free play clearance is not within specifications adjust as necessary. First loosen the jam nut and turn the adjustment bolt.



### Step 5

After adjustment reconfirm the clearance is within specifications.

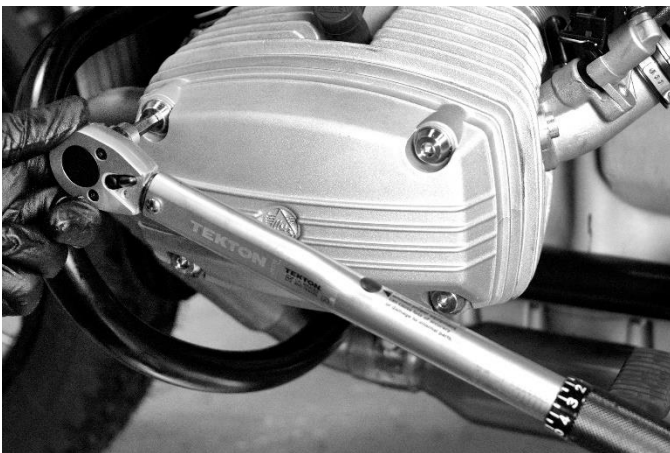

### Step 6

Replace the valve cover gasket, bolt seals and re-torque the valve cover bolts.

### Step 7

Repeat the process on the right side by rotating the engine with the kick starter 360 degrees. Again, both valves will be closed and the TDC mark should be centered in the window.

### CAUTION

**OPERATING THE ENGINE WITH IMPROPERLY ADJUSTED VALVES CAN LEAD TO POOR PERFORMANCE AND POSSIBLE ENGINE DAMAGE.**

## FRONT BRAKE SYSTEM MAINTENANCE



### Step 1

Remove the retaining pin safety clips.

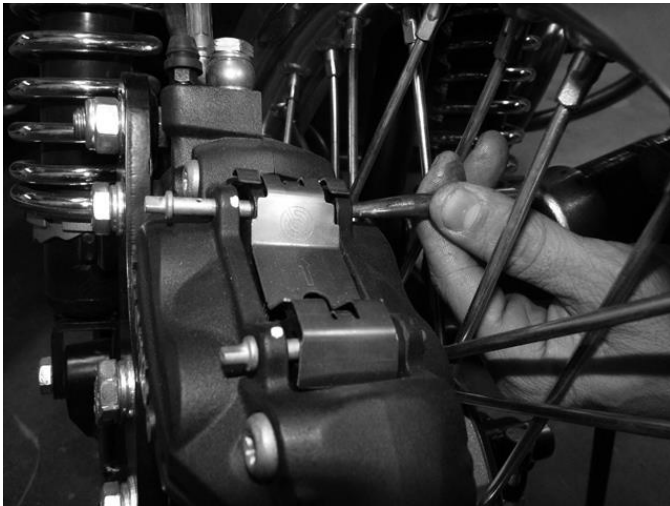

### Step 2

Carefully drive the retaining pins out of the caliper using a small punch or drift.

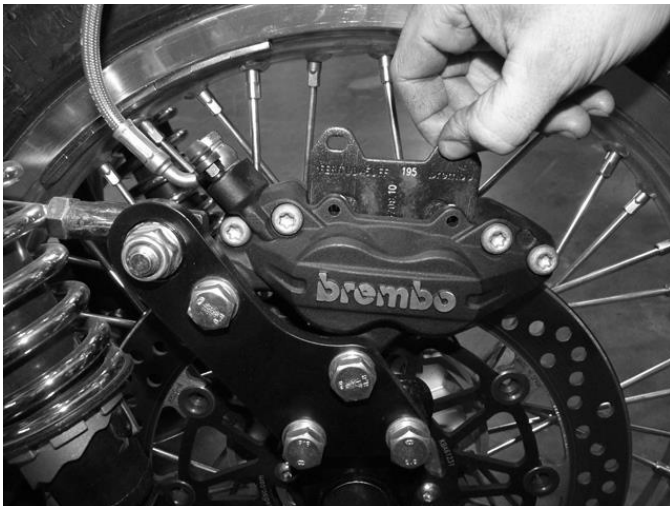

### Step 3

Remove the brake pads by pulling them out the top of the caliper.

## FRONT BRAKE SYSTEM MAINTENANCE (CONT.)



### Step 4

Inspect the brake pads and replace as needed.

#### NOTE

**MINIMUM PAD THICKNESS IS 1MM**

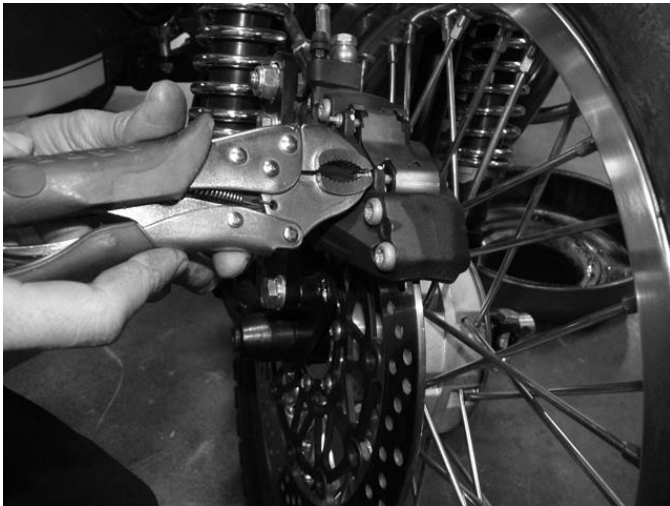

### Step 5

Re-install brake pads in reverse order.

Be sure to fully seat the retaining pins and install the safety clips.

### Step 6

Confirm the brake fluid level is full in the reservoir and add as needed to FULL line.

**DO NOT OVER FILL**

#### CAUTION

**OPERATING THE MOTORCYCLE WITH WORN BRAKE PADS CAN CAUSE DAMAGE TO THE BRAKE ROTORS.**

#### WARNING

**OPERATING THE MOTORCYCLE WITH WORN BRAKE PADS BELOW THE MINIMUM THICKNESS CAN RESULT IN POOR BRAKING AND POSSIBLE ACCIDENT.**

#### WARNING

**OPERATING THE MOTORCYCLE WITH LOW FLUID LEVEL CAN CAUSE LOSS OF BRAKING FORCE.**



## REAR BRAKE SYSTEM MAINTENANCE



### Step 1

Place the bike on the center stand. Remove lower shock mounting bolt and swing the shock back to access brake caliper.



### Step 2

Remove the caliper mounting bolts and remove the caliper.



### Step 3

Remove the caliper safety clip and carefully remove the retaining pin out of the caliper. A punch or drift may be used.



## REAR BRAKE SYSTEM MAINTENANCE (CONT.)



### Step 4

Remove and inspect the brake pad, replace as needed.

#### NOTE

MINIMUM PAD THICKNESS IS 1MM

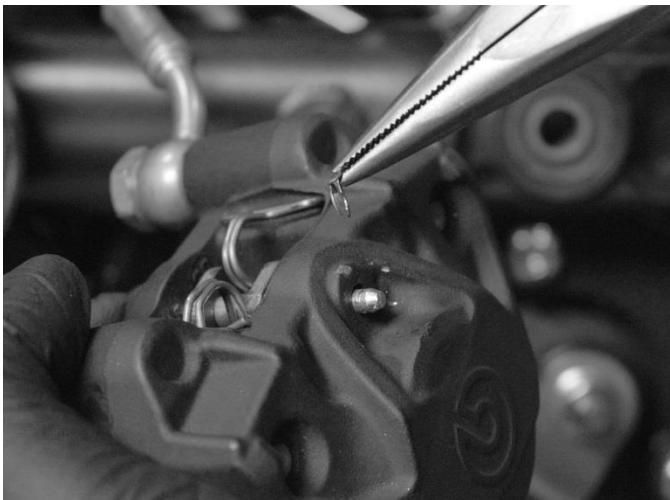

### Step 5

Re-install brake pads in reverse order. DO NOT forget to install the safety clip.

### Step 6

Confirm the brake fluid level is full in the reservoir and add as needed to FULL line.

**DO NOT OVER FILL**

#### CAUTION

OPERATING THE MOTORCYCLE WITH WORN BRAKE PADS CAN CAUSE DAMAGE TO THE BRAKE ROTORS.

#### WARNING

OPERATING THE MOTORCYCLE WITH WORN BRAKE PADS BELOW THE MINIMUM THICKNESS CAN RESULT IN POOR BRAKING AND POSSIBLE ACCIDENT.

#### WARNING

OPERATING THE MOTORCYCLE WITH LOW FLUID LEVEL CAN CAUSE LOSS OF BRAKING FORCE.

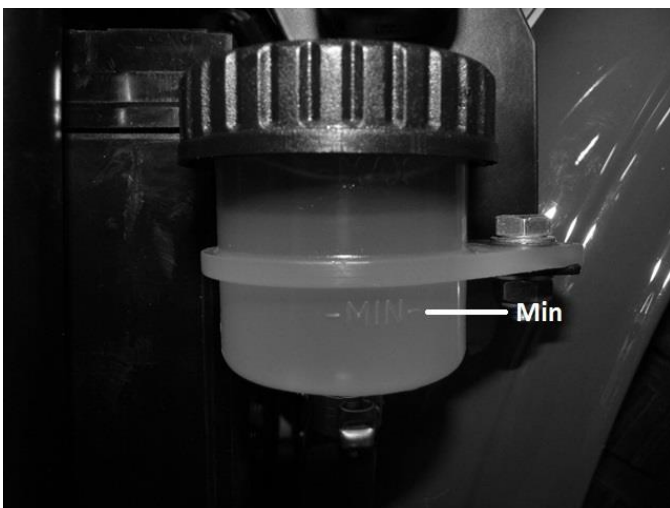

## PARKING BRAKE ADJUSTMENT



### Step 1

Locate the cable adjuster connected to the parking brake handle and be sure the parking brake is in the “off” position.



### Step 2

Adjust the cable to remove excess free play by tightening lower adjustment nut.



### NOTE

**ADJUST CABLE FOR MINIMAL FREEPLAY WITHOUT DRAG. ROTATE WHEEL AND INSPECT FOR FREE ROTATION.**

## SIDECAR BRAKE SYSTEM MAINTENANCE



### Step 1

Remove the caliper mounting bolts.



### Step 2

Remove the caliper from the sidecar swing arm.



### Step 3

Remove the caliper safety clip and carefully drive the retaining pin out of the caliper with a punch or drift.



## SIDECAR BRAKE SYSTEM MAINTENANCE (CONT.)



### Step 4

Remove the brake pads by pulling them out of the bottom of the caliper.



### Step 5

Inspect the brake pads and replace as needed.

#### NOTE

**MINIMUM PAD THICKNESS IS 1MM**

### Step 6

Re-install the brake pads and caliper in reverse order. **DO NOT** forget to install the safety clip.

### Step 7

Confirm the brake fluid level is full in the reservoir and add as needed to **FULL** line.

**DO NOT OVER FILL**

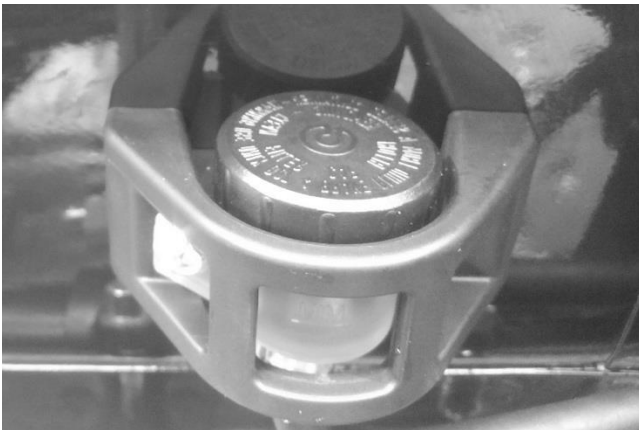

#### CAUTION

**OPERATING THE MOTORCYCLE WITH WORN BRAKE PADS CAN CAUSE DAMAGE TO THE BRAKE ROTORS.**

#### WARNING

**OPERATING THE MOTORCYCLE WITH WORN BRAKE PADS BELOW THE MINIMUM THICKNESS CAN RESULT IN POOR BRAKING AND POSSIBLE ACCIDENT.**

#### WARNING

**OPERATING THE MOTORCYCLE WITH LOW FLUID LEVEL CAN CAUSE LOSS OF BRAKING FORCE.**

## FRONT WHEEL REMOVAL & INSTALLATION

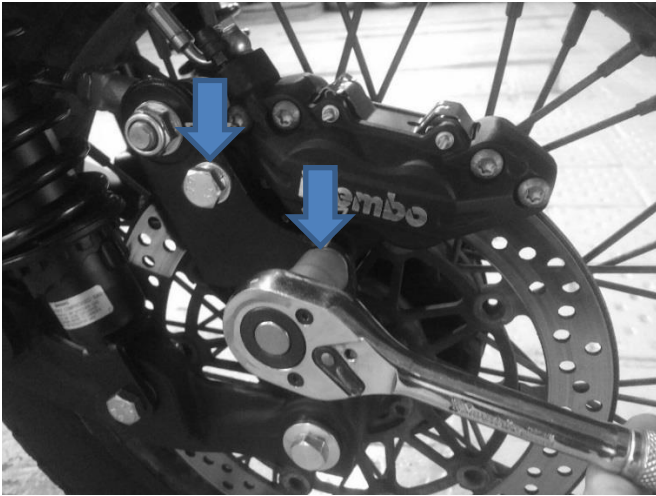

### Step 1

Raise front wheel off the ground

### Step 2

Remove the lower caliper mounting bracket bolts.

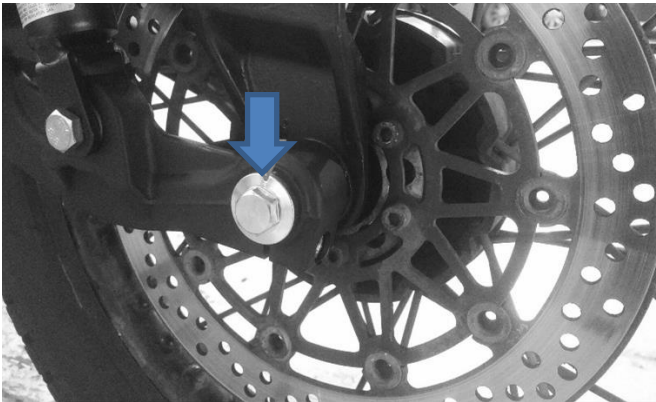

### Step 3

Loosen the axle pinch bolt.

|             |
|-------------|
| <b>NOTE</b> |
|-------------|

FRONT AXLE BOLT IS LEFT HANDED TRHEADS



## FRONT WHEEL REMOVAL & INSTALLATION (CONT.)



### Step 4

Loosen the 2 axle pinch bolts.



### Step 5

Remove the axle from the wheel. Remove the front wheel with the caliper bracket.



### Step 6

To re-install the wheel place the caliper mount into the wheel first

### Step 7

Position the wheel on the bike and install the axle.

## FRONT WHEEL REMOVAL & INSTALLATION (CONT.)

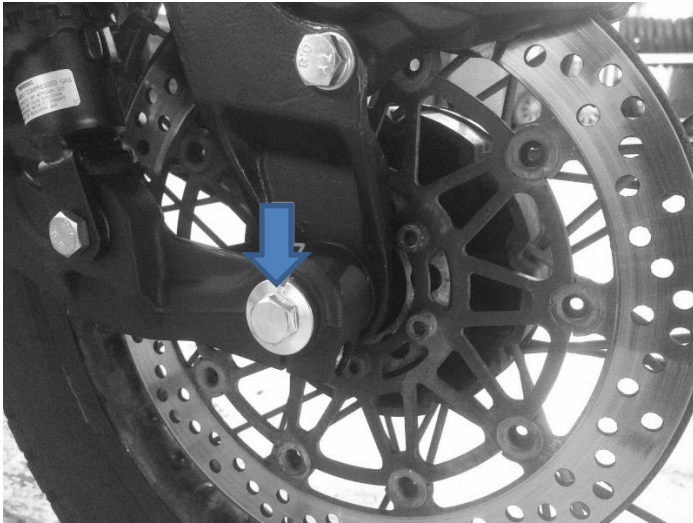

### Step 8

Reinstall and tighten the axle bolt.

### NOTE

FRONT AXLE BOLT IS LEFT HANDED TRHEADS



### Step 9

Tighten the 2 axle pinch bolts according to specification

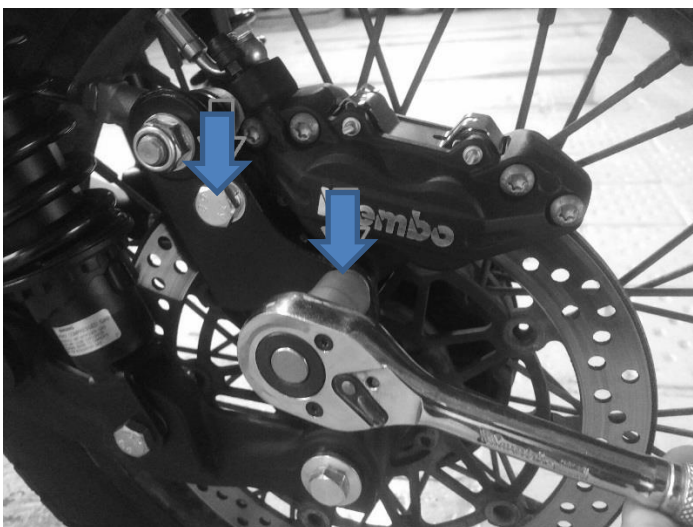

### Step 10

Re-attach the caliper with mounting brackets and tighten according to specification.

## REAR WHEEL REMOVAL & INSTALLATION



### Step 1

Place the motorcycle on the center stand.

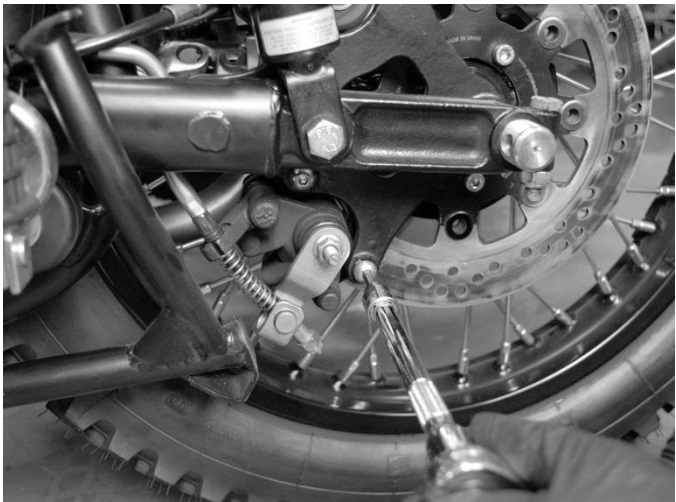

### Step 2

Remove the parking brake caliper using a 5mm hex key wrench.

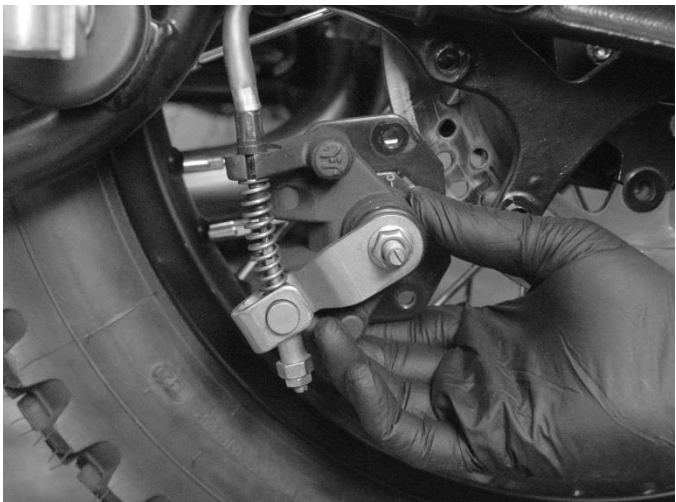

### Step 3

Allow the parking brake caliper to drop down and out of the way.



## REAR WHEEL REMOVAL & INSTALLATION (CONT.)

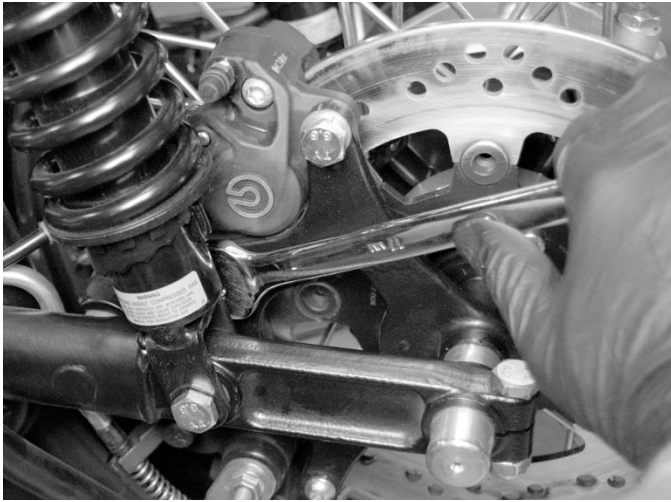

### Step 4

Loosen both brake caliper mounting bolts using a 17mm wrench.



### Step 5

Remove the axle nut.

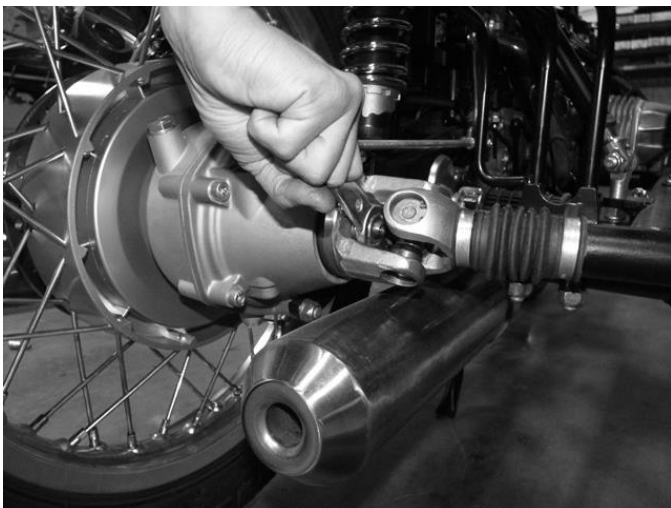

### Step 6

Loosen the axle pinch bolt.

## REAR WHEEL REMOVAL & INSTALLATION (CONT.)



**Step 7**  
Remove the axle.

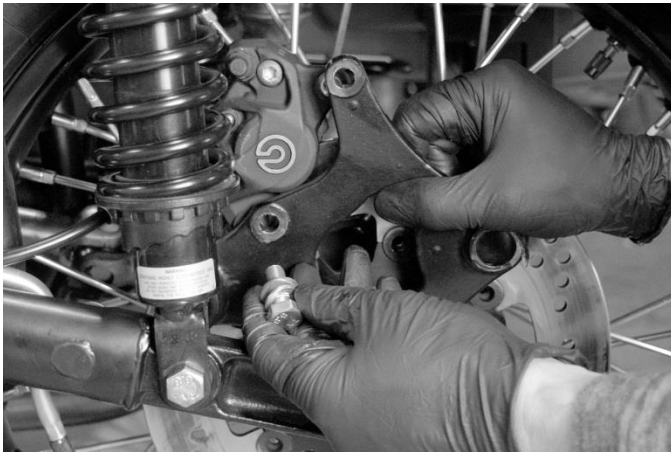

**Step 8**  
Pull brake caliper mounting plate back and remove caliper bolts.



**Step 9**  
Remove brake mounting plate.

## REAR WHEEL REMOVAL & INSTALLATION (CONT.)



### Step 10

Remove the rear wheel by tilting it outwards towards you and rolling it back as shown.

|             |
|-------------|
| <b>NOTE</b> |
|-------------|

Re-install the rear wheel in reverse order.  
Torque all fasteners to specification.



## SIDECAR WHEEL REMOVAL & INSTALLATION



### Step 1

Remove the sidecar brake caliper.



### Step 2

Carefully remove the sidecar hub cap.



### Step 3

Remove the axle cotter pin and axle nut.

### Step 4

Re-install the sidecar wheel in reverse order.

## USING THE SPARE WHEEL



### NOTE

**THE SPARE WHEEL COMES EQUIPPED FOR USE ON THE REAR POSITION.**

#### **Step 1**

Remove the rear wheel and rear brake rotor.

#### **Step 2**

Install the brake rotor on the spare wheel and torque to specification.

#### **Step 3**

Install the spare wheel on the motorcycle.

## WHEEL SPOKE MAINTENANCE



The wheel spokes should be checked on a regular basis and per the maintenance intervals.

Check spoke tension by lightly tapping each spoke and listening to the ring. Loose spokes will make a low flat sound.

#### **Step 1**

Tap each spoke and compare the sound from one to another.



#### **Step 2**

Tighten spokes as needed. If spokes require more than ½ turn to tighten you may need to remove the tire and have the wheel professionally trued.

## WHEEL BEARING REPLACEMENT & DIAGRAMS



The wheel bearings are sealed type and cannot be serviced, only replaced.

The bearings should be inspected and replaced per the maintenance intervals.

### Step 1

Remove the wheel.

### Step 2

Remove the dust seals and retaining clips.

### Step 3

Carefully drive the bearings out of the hub and replace.

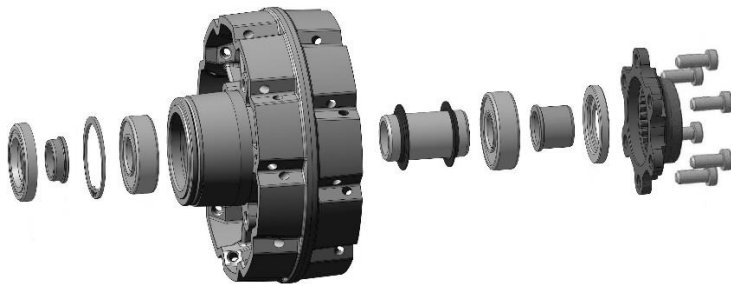

### Step 4

Re-install in reverse order replacing the dust seals as needed.

#### NOTE

WHEEL BEARINGS SHOULD BE INSPECTED AND REPLACED MORE FREQUENTLY THAN OUTLINED IN THE MAINTENANCE SCHEDULE WHEN THE MOTORCYCLE IS USED OFF ROAD OR IN ADVERSE WEATHER ON A REGULAR BASIS.

#### CAUTION

FAILURE TO REPLACE THE WHEEL BEARINGS WHEN NEEDED CAN DAMAGE THE WHEEL HUB AND AXLE.

#### WARNING

DAMAGED AND/OR WORN BEARINGS CAN PREVENT THE WHEEL FROM ROTATING FREELY.

## TIRE & TUBE REPLACEMENT



### Step 1

Remove the valve stem and deflate the tire.



### Step 2

Using the provided tire spoons in your tool kit carefully remove one side of the tire from the rim.



### Step 3

Remove the tube from the tire.

### Step 4

Remove the tire from the rim.

### Step 5

Re-install the tire in reverse order; be careful not to pinch the tube during installation.

|             |
|-------------|
| <b>NOTE</b> |
|-------------|

**WHEN INFLATING THE TIRE, BE SURE THE TIRE BEAD IS FULLY SEATED AND EVEN AROUND THE RIM.**

## **SIDECAR ALIGNMENT**

The sidecar should be installed in a definite position relative to the motorcycle. The position is determined by the camber and toe-in of the motorcycle and the side car wheels. An incorrectly aligned side car will drag the motorcycle to either side and cause extensive tire wear. If the motorcycle is not stable on the road or is difficult to steer, check the alignment. Checking and measuring the alignment should be done on level ground.

Check toe-in of the motorcycle and the side car wheels with two straight bars applied to the side faces of the wheels just below the axles. The toe-in should be 3 to 8mm (2wd models) or 8 to 12mm (1wd models) at the front wheel. When adjusting, unbolt the top of the strut legs fastening the side car to the motorcycle, loosen the bolt clamping the lower rear bracket, and adjust the position of the bracket relative to the rear tube of the side car frame to obtain necessary toe-in of the wheels. Tighten up the bolt fastening the bracket, adjust the length of the strut legs and secure them with bolts.

Check the lean-out of the motorcycle using a level gauge or protractor with a plumb bob and a ruler; standard lean-out is 1-2 degrees. Adjust the two inclined legs by screwing the forks in or out. When the lean-out is correct, the rider will remain vertical while riding on the local roads which may be slightly sloped to assist with water runoff.

Check the toe-in while the motorcycle is running on the road. With the toe-in properly adjusted, the motorcycle will not pull to either side while running at normal road speed. If it pulls to the right, increase the toe-in, if it pulls to the left, decrease the toe-in.

|                |
|----------------|
| <b>CAUTION</b> |
|----------------|

**DOUBLE CHECK FOR CORRECT TOE-IN BEFORE MAKING ANY CHANGE TO LEAN-OUT.**

# SIDECAR ALIGNMENT DIAGRAM

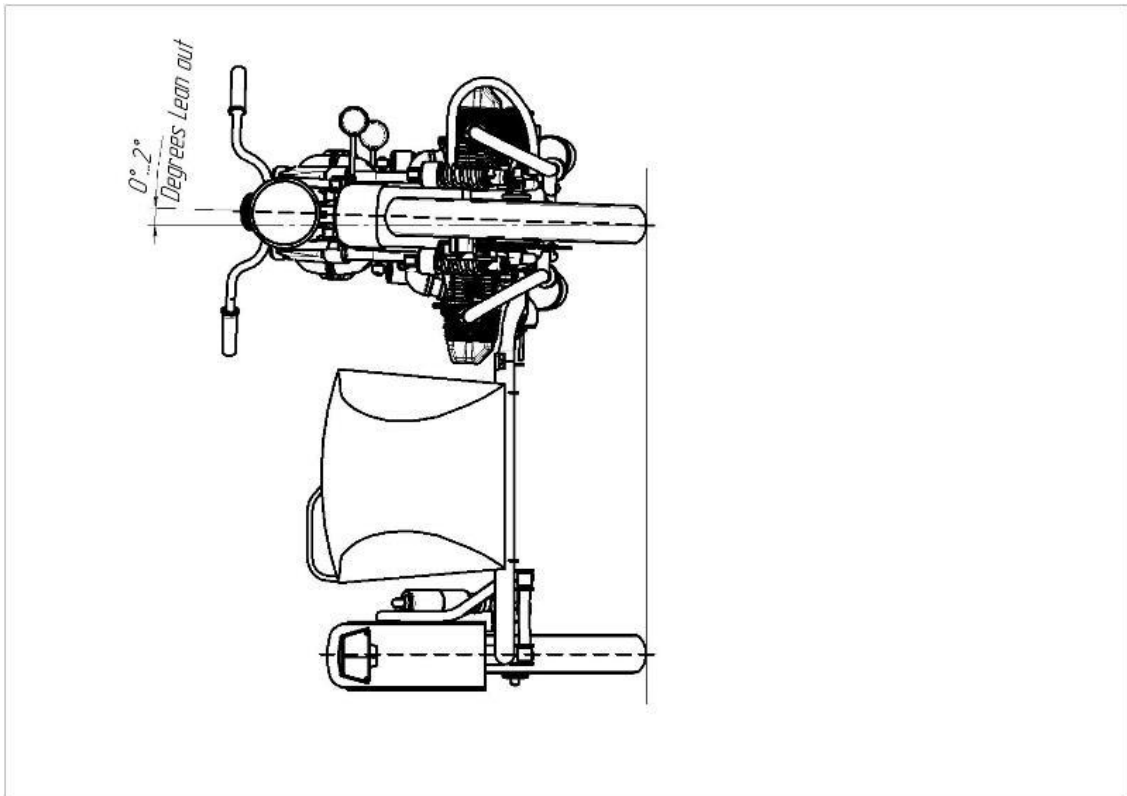
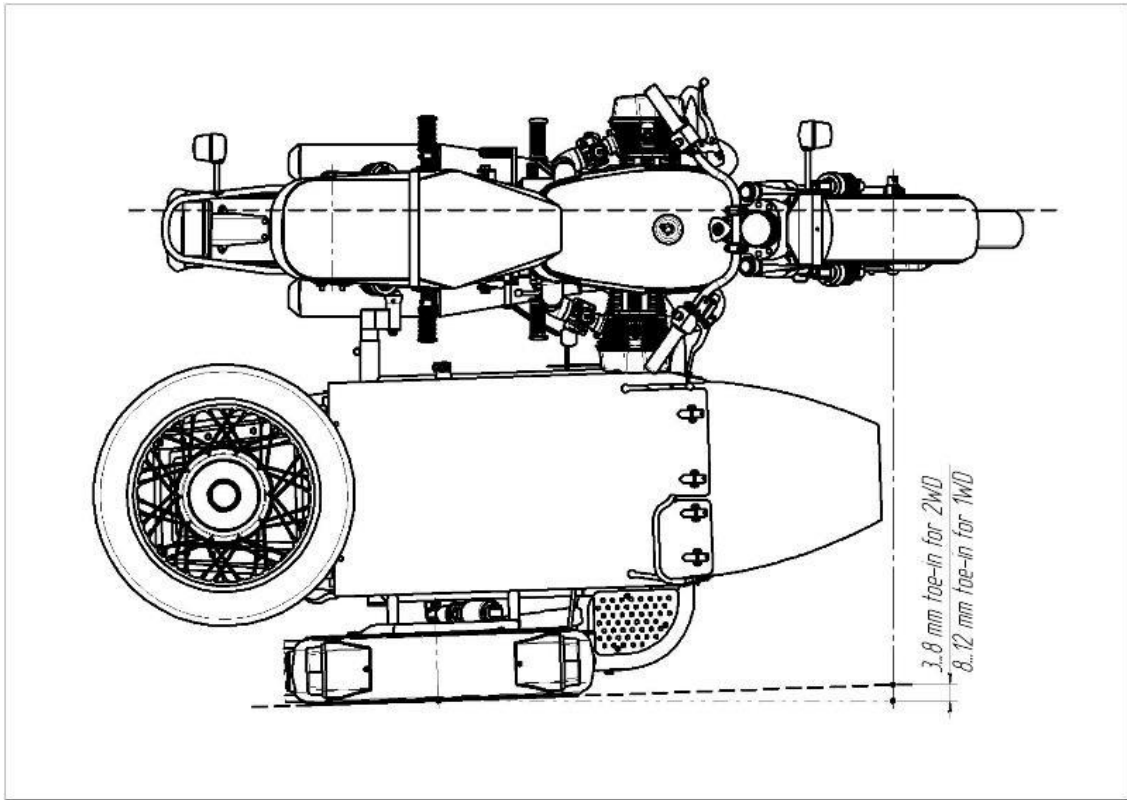

## 6. Electrical

|                                   | Page |
|-----------------------------------|------|
| Lamp & Bulb Replacement           | 6-2  |
| Battery Maintenance & Replacement | 6-6  |
| Fuse & Relay Locations            | 6-9  |
| Sidecar Fuse & Relay Locations    | 6-10 |
| Starter                           | 6-11 |
| Alternator                        | 6-11 |
| ECU Data Port                     | 6-11 |

## LAMP & BULB REPLACEMENT (HEADLIGHT)



### Headlight Replacement

#### Step 1

Remove the lamp retaining ring screw and pull the lamp out of the bucket.

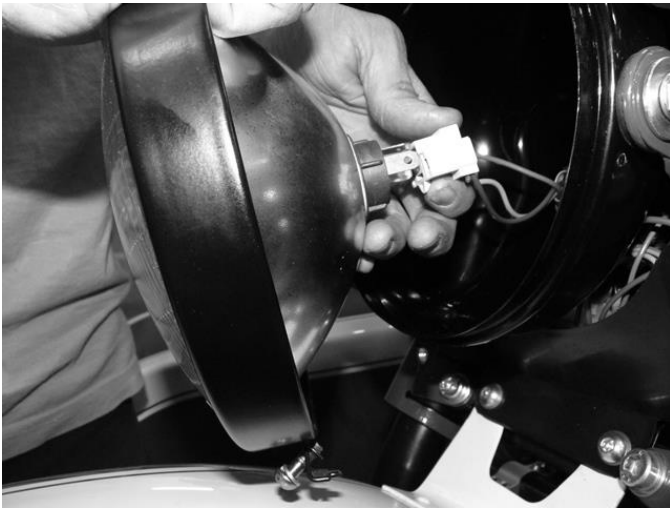

#### Step 2

Disconnect the lamp.



#### Step 3

Carefully remove the lamp retaining clips and replace lamp.

#### Step 4

Re-install in reverse order.

#### WARNING

**ALWAYS WEAR EYE PROTECTION WHEN REMOVING LAMP RETAINING CLIPS.**

#### WARNING

**IT IS UNSAFE TO OPERATE YOUR MOTORCYCLE WITHOUT A FUNCTIONING HEADLIGHT.**



## LAMP & BULB REPLACEMENT (TAIL LIGHT)

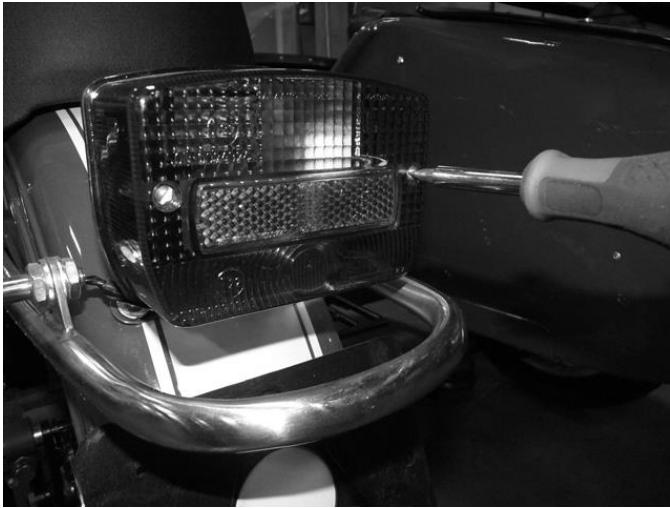

### Tail Light Replacement

#### Step 1

Remove the tail light lens retaining screws.



#### Step 2

Inspect and replace bulbs as needed. The upper bulb in the running/brake lamp and the lower is the license plate lamp.

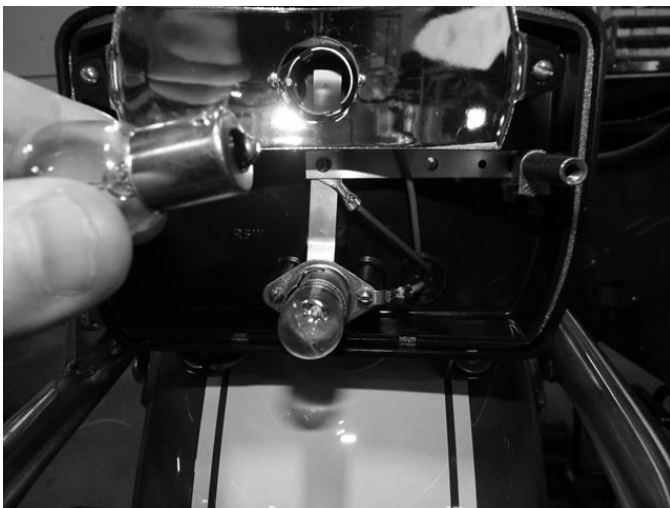

#### Step 3

To remove the bulb twist and pull.

#### Step 4

Re-install the bulbs in reverse order.

#### NOTE

TO HELP PREVENT CORRODED CONTACTS USE DIELECTRIC GREASE.

#### WARNING

IT IS UNSAFE TO OPERATE YOUR MOTORCYCLE WITHOUT A FUNCTIONING TAIL AND BRAKE LIGHT.

## LAMP & BULB REPLACEMENT (TURN SIGNALS)



### Turn Signal Bulb Replacement

#### Step 1

Remove the turn signal lens retaining screws.

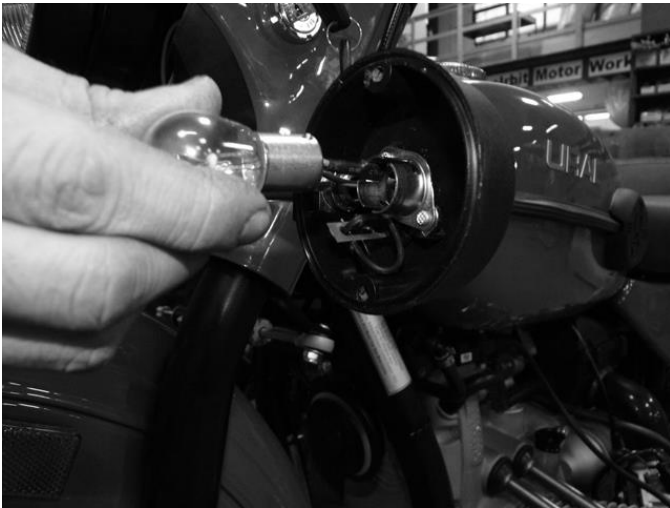

#### Step 2

Inspect and replace bulbs as needed.

#### Step 3

To remove the bulb twist and pull.



#### Step 4

Re-install the bulbs in reverse order.

#### NOTE

TO HELP PREVENT CORODED CONTACTS USE DIELECTRIC GREASE.

#### WARNING

IT IS UNSAFE TO OPERATE YOUR MOTORCYCLE WITHOUT FUNCTIONING TURN SIGNALS.

## LAMP & BULB REPLACEMENT (SIDECAR LAMPS)



### Sidecar Lamps

#### Step 1

Remove the lens retaining screws.

#### Step 2

Inspect and replace bulbs as needed.



#### Step 3

To remove the bulb twist and pull.

#### Step 4

Be sure to re-install the lens gasket.



#### Step 5

Re-install the bulbs in reverse order.

#### NOTE

**TAIL LIGHT/BRAKE ON LEFT AND SIGNAL ON RIGHT**

#### NOTE

**TO HELP PREVENT CORODED CONTACTS USE DIELECTRIC GREASE.**

#### WARNING

**IT IS UNSAFE TO OPERATE YOUR MOTORCYCLE WITHOUT FUNCTIONING SIDECAR LAMPS.**

## BATTERY MAINTENANCE

Stock battery on the motorcycle should function at ambient air temperature from -40°C to plus 60°C/ 40°F to 140°F.

As the battery is in service:

- Regularly check the voltage for 13.8 - 14.2 V
- Do not allow the battery to discharge.
- Coat bolts, nuts, washers and tips with petroleum jelly or battery grease. Use two wrenches for clamping or undoing the nuts to avoid breaking battery parts.

Before storage, fully charge the battery, wash the battery surface with water and wipe dry, clean the bolts and nuts of dirt.

### WARNING

BATTERIES CONTAIN SULFURIC ACID WHICH CAN CAUSE SEVERE BURNS. AVOID CONTACT WITH SKIN, EYS OR CLOTHING.

### ANTIDOTE

**EXTERNAL** – FLUSH WITH WATER.

**INTERNAL** – DRINK LARGE QUANTITIES OF WATER FOLLOWED BY MILK OF MAGNESIA, VEGETABLE OIL, OR BEATEN EGGS.

**CALL DOCTOR IMMEDIATELY**

### CAUTION

WHEN CHARGING THE BATTERY, DISCONNECT THE NEGATIVE TERMINAL FROM THE BATTERY TO PREVENT DAMAGE TO ELECTRICAL COMPONENTS.

**NEVER JUMP START THE MOTORCYCLE!**

### WARNING

BATTERIES PRODUCE EXPLOSIVE HYDROGEN GAS AT ALL TIMES – ESPECIALLY WHEN BEING CHARGED. KEEP ANY OPEN FLAMES AND/OR SPARKS AWAY FROM THE BATTERY AT ALL TIMES. ALWAYS PROTECT HANDS AND FACE WHEN WORKING ON AND/OR NEAR A BATTERY.

**KEEP BATTERIES OUT OF REACH OF CHILDREN AND PETS!**

## BATTERY REPLACEMENT



### Step 1

Disconnect the white negative (-) battery cable.



### Step 2

Disconnect the positive (+) battery cable

### Step 3

Remove the battery hold down straps.

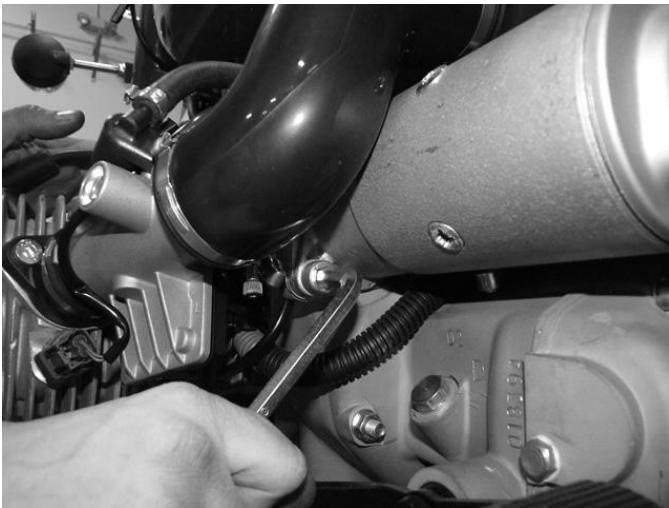

### Step 4

Loosen both the upper and lower starter bolts to allow clearance for battery removal.

#### CAUTION

ALWAYS DISCONNECT THE NEGATIVE (-) BATTERY CABLE FIRST TO AVOID SHORTING THE BATTERY.

#### WARNING

SHORTING THE BATTERY TERMINALS COULD RESULT IN A FIRE.

## BATTERY REPLACEMENT (CONT.)



### Step 5

Carefully slide the battery out between the frame tube and air box.



### Step 6

Re-install in reverse order by sliding the battery back into place and reconnecting all straps and cables.



### Step 7

Be sure to re-tighten the starter bolts.

#### CAUTION

**ALWAYS RECONNECT THE POSITIVE (+) BATTERY CABLE FIRST TO AVOID SPARKS.**

#### NOTE

**USE DIELECTRIC GREASE ON THE BATTERY CONNECTIONS TO PREVENT CORROSION.**

## FUSE & RELAY LOCATIONS

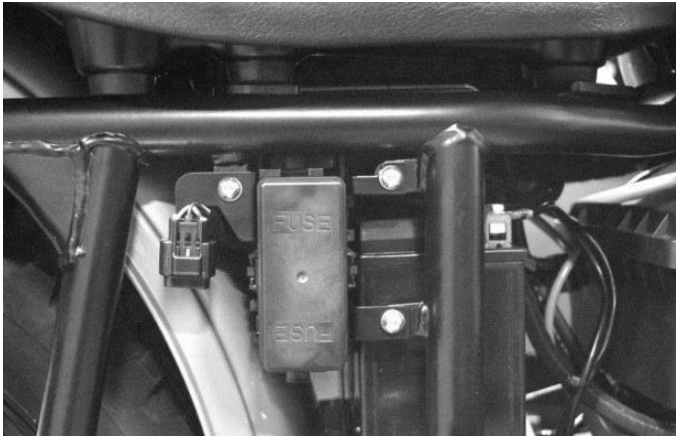

### Fuse Box Main

The main motorcycle fuse box is located under the left side panel.

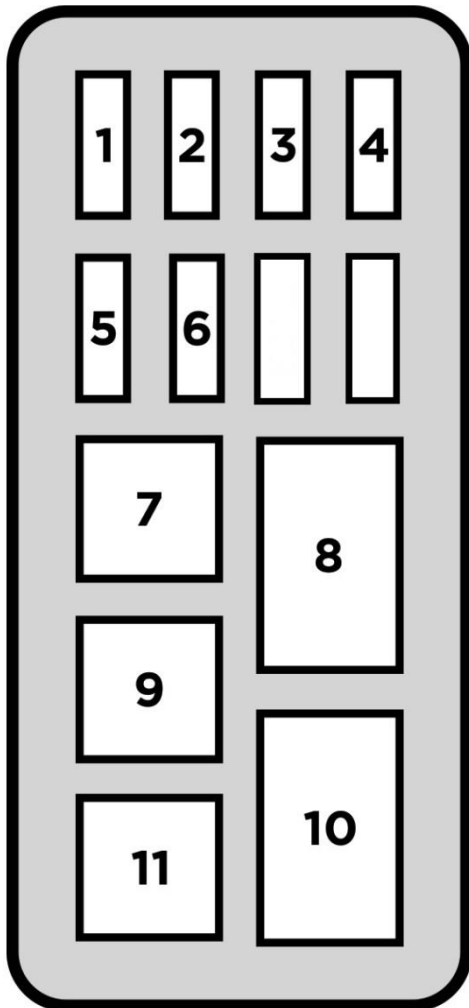

### Fuse Box Diagram

This diagram shows the position and function for each fuse and relay in the fuse box.

- |                             |     |
|-----------------------------|-----|
| 1. ECU Power                | 10a |
| 2. ECU Relay Power          | 15a |
| 3. Ignition/Starter/Signals | 15a |
| 4. Brake Lights/Horn/EVAP   | 15a |
| 5. Lights/High Beam         | 15a |
| 6. Parking Lights           | 15a |
| 7. Headlight Relay          |     |
| 8. ECU Relay                |     |
| 9. Starter Lock-out Relay   |     |
| 10. Lighting Relay          |     |
| 11. Starter Relay           |     |

## FUSE & RELAY LOCATIONS (CONT.)



### Turn Signal Relay

The turn signal relay is located behind the headlight bucket. To access this relay you must first remove the headlight bucket assembly.

## SIDECAR FUSE & RELAY LOCATIONS



### Fuse Box Sidecar

The sidecar fuse box is located on the left hand interior body panel of the sidecar.

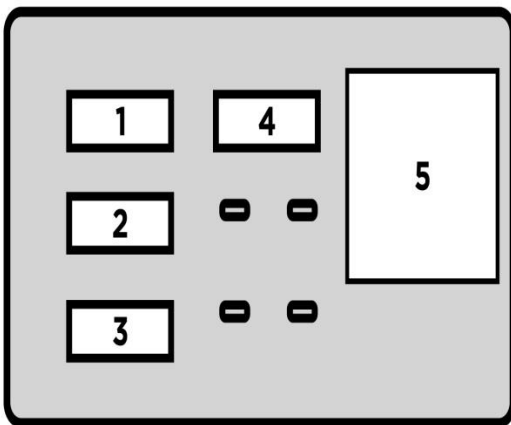

### Fuse Box Diagram

This diagram shows the position and function for each fuse and relay in the fuse box.

- |                            |            |
|----------------------------|------------|
| <b>1. Power Outlet</b>     | <b>15a</b> |
| <b>2. Accessory Switch</b> | <b>15a</b> |
| <b>3. Accessory</b>        | <b>15a</b> |
| <b>4. Spotlight</b>        | <b>15a</b> |
| <b>5. Spotlight Relay</b>  |            |



## ELECTRIC STARTER

The starter must provide 300-400 rpm to start the engine and requires a well maintained battery. If battery is below required the voltage the electric starter may not operate efficiently. If the battery becomes low you may need to use the kick starter.

## ALTERNATOR

This motorcycle is equipped with a Denso Alternator.

Specifications:

Rated Voltage 12V

Rated Output 40A, 480W

Peak Output 560W @ 14V

Testing the Alternator on the Motorcycle

If no test bench is available, check the output of the alternator with the engine running.

- Connect the voltmeter to positive and negative terminals of the storage battery
- Start the engine
- While starting the voltage will drop to as low as 9.5 V
- At 3500-4000 rpm output voltage should be 13.5-14.5 VDC

In the course of daily inspection, check the fastening of wires to the alternator terminals and fastening of the alternator on the engine crankcase.

## ECU DATA PORT

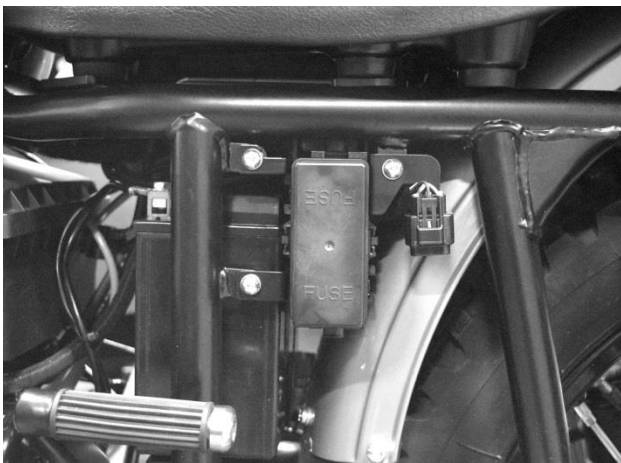

The ECU Data port is located behind the left side panel. This data port is intended for:

**DEALER ONLY EFI DIAGNOSTICS**

The data port has a protective cap that should be left in place to prevent debris from contaminating the connector.

## 7. EFI Troubleshooting

|                                     | Page |
|-------------------------------------|------|
| Engine Management (MIL Blink Codes) | 7-2  |
| Service Notes                       | 7-4  |

# URAL ENGINE MANAGEMENT SYSTEM BLINK DIAGNOSTICS

## Introduction

A basic blink code system has been implemented on the Ural EFI bikes to aid EMS (Engine Management System) diagnostics without the need for an additional computer diagnostic tool, greatly helping the user when during travels. When activated, the MIL (malfunction indicator lamp) blinks out a code sequence relating to the fault.

## Operation

When the MIL is continuously lit with the key on, an EMS fault has occurred. Activate the blink code by turning the key on and toggling the key switch 3 times (Off->On->Off->On->Off->On) within 10 seconds. MIL will blink the code "02" indicating the ECU is in blink mode.

Once in blink mode, the ECU will blink the code "02" first and then blink a unique code for each possible system fault in a consecutive fashion, before cycling back to the beginning.

The ECU will remain in this mode until the Key switch is turned off for more than 10 seconds.

| Blink Code | Fault Code (P) | Fault Description                         | MIL Activation Criteria                         |
|------------|----------------|---|---|
| 13         | P0107          | Pressure sensor open or short to GND      | Detected circuit open                           |
| 13         | P0108          | Pressure sensor short to battery          | Detected circuit short to battery               |
| 28         | P0117          | Engine temp sensor short to ground        | Detected circuit short to GND                   |
| 28         | P0118          | Engine temp sensor open                   | Detected circuit open                           |
| 46         | P0563          | Battery voltage high                      | Voltage measured above 16V                      |
| 15         | P0122          | TPS open or short to GND                  | Detected circuit open                           |
| 15         | P0123          | TPS short to battery                      | Detected circuit short to battery               |
| 24         | P0131          | NB O2 open or short to GND                | Detected circuit short to GND                   |
| 24         | P0132          | NB O2 short to battery                    | Detected circuit short to battery               |
| 11         | P0231          | Fuel pump open or short to GND            | Detected circuit open                           |
| 17         | P0232          | Fuel pump short to battery                | Detected circuit short to battery               |
| 44         | P0601          | EEPROM error                              | Fault detected                                  |
| 39         | P0261          | Injector open or short to GND             | Detected circuit open                           |
| 39         | P0262          | Injector short to battery                 | Detected circuit short to battery               |
| 33         | P1351          | Ignition Coil open or short to GND        | Detected circuit open                           |
| 33         | P0351          | Ignition Coil short to battery            | Detected circuit short to battery               |
| 34         | P0335          | Crank sensor error                        | Signal miss counted while the engine is running |
| 35         | P0298          | Engine over heat                          | Temperature measured above 170°C                |
| 36         | P1352          | Cyl2 Ignition Coil open or short to GND   | Detected circuit open                           |
| 38         | P0352          | Cyl2 Ignition Coil short to battery       | Detected circuit short to battery               |
| 47         | P0264          | Cyl2 Injector open or short to GND        | Detected circuit open                           |
| 48         | P0265          | Cyl2 Injector short to battery            | Detected circuit short to battery               |
| 12         | P1335          | Crank sensor open or short to GND         | Running engine without signal detected.         |
| 51         | P0135          | NB O2 heater short to battery             | Detected circuit short to battery               |
| 52         | P1135          | NB O2 heater open or short to GND         | Detected circuit open                           |
| 31         | P0508          | ISC open or short to GND                  | Detected circuit open                           |
| 32         | P0509          | ISC short to battery                      | Detected circuit short to battery               |
| 37         | P0505          | Step Motor Rationality                    | Self-diag function of the control IC            |
| 61         | P1509          | Step Motor Output Over Temperature        | Self-diag function of the control IC            |
| 41         | P0151          | O2B open or short to GND                  | Detected circuit short to GND or Open           |
| 42         | P0152          | O2B short to battery                      | Detected circuit short to battery               |
| 62         | P0155          | O2B heater short to battery               | Detected circuit short to battery               |
| 63         | P1155          | O2B heater open or short to GND           | Detected circuit short to GND or Open           |
| 65         | P0444          | Canister purge valve open or short to GND | Detected circuit open                           |
| 66         | P0445          | Canister purge valve short battery        | Detected circuit short to battery               |

## SERVICE NOTES

## 8. Warranty Information

|                                      | Page |
|--------------------------------------|------|
| Warranty Agreement                   | 8-2  |
| Warranty Disclaimers                 | 8-3  |
| Limited Emissions Warranty           | 8-5  |
| California Emissions Statement       | 8-7  |
| Extended Warranty                    | 8-8  |
| Spare Parts and Accessories Warranty | 8-8  |
| Reporting Safety Defects             | 8-9  |

## **URAL MOTORCYCLES LIMITED WARRANTY**

Ural Motorcycles warrants to the first retail purchaser of the URAL motorcycle from an authorized dealer and each subsequent owner that the motorcycle is free from defects in materials and workmanship for the period stated below.

### **To Qualify For This Warranty**

- The URAL® motorcycle must be purchased from a dealer within the United States or Canada who is authorized by Ural Motorcycles to sell motorcycles (see [www.imz-ural.com](http://www.imz-ural.com) for a complete list of authorized dealers).
- Prior to delivery to the purchaser, the dealer who is authorized by Ural Motorcycles to sell motorcycles must perform the complete set-up and pre-delivery procedures.

### **Warranty Time Period for Current Model Year**

- Duration of Ural Motorcycles Limited Warranty is 24 months, starting with the earlier of (a) the date the motorcycle is sold to the first retail purchaser and the warranty registration card is received by Ural Motorcycles, or (b) after 12 months in the selling dealer's inventory.
- There is no mileage limitation.
- Any unexpired portion of this limited warranty will be transferred to subsequent owners, upon the resale of the motorcycle during the limited warranty period.

### **Warranty Coverage**

- To obtain warranty service, return your motorcycle at your expense within the limited warranty period to an authorized Ural dealer. The authorized Ural dealer should be able to provide warranty service during normal business hours, depending upon the workload of the authorized dealer's service department and the availability of necessary parts.
- Ural Motorcycles will repair or replace, at its option, any parts (including parts of the emission control systems) that are found to be defective in material or workmanship under normal use for the applicable time period.
- In cases when warranty repair takes longer than 14 days, the warranty time period (see Warranty Time Period) is extended for the period of time required to complete the repairs, during which the motorcycle could not be ridden.
- Ural Motorcycles will reimburse non-URAL repair shops performing warranty repairs only if all the warranty processing and approval procedures are completely fulfilled and/or carried out according to Ural Motorcycles guidelines (see Warranty Claim Filing Procedures).

## **WARRANTY DISCLAIMERS LIMITATIONS & EXCLUSIONS**

### **Ural Motorcycles Disclaims Any Responsibility For:**

- Loss of time due to warrantable issues and/or repairs.
- Loss of use of motorcycle dues to warrantable repairs.
- Transportation expenses including, but not limited to, towing and/or rentals.
- Any other incidental or consequential damages and/or expenses.

### **THERE IS NO OTHER EXPRESSED WARRANTY (OTHER THAN THE SEPARATE EMISSIONS LIMITED WARRANTIES) ON THE MOTORCYCLE.**

Any implied warranty of merchantability or fitness for particular purpose is limited to the duration of the express warranty, or to the duration set forth in your state's warranty statutes, whichever is shorter.

### **State Laws May Vary**

The previous listed limitations or exclusions may not apply to a motorcycle because of state laws. Some states may not allow limitations on how long an implied warranty lasts. Some states may not allow exclusion or limitation of incidental or consequential damages.

### **These Warranties Do Not Cover:**

1. Failures or required services that is not due to a defect in material or factory workmanship
2. Parts or accessories affected or damaged by:
  - Lack of required maintenance
  - Owner abuse
  - Accident and/or collision
  - Misuse
  - Normal wear
  - Neglect
  - Improper installation
  - Unsuitable use in an application for which the part was not designed
  - The incorporation or use of unsuitable attachments or parts
  - The unauthorized alteration of any part or system
  - Deterioration from the elements
  - Failure to follow running-in (break-in) procedure
3. Replacement of expendable maintenance items including, but not limited to:
  - Spark plugs
  - Filters
  - Lubricants
  - Compliance fittings (throttle body mounting flanges)
  - Tires
  - Gaskets
  - Fuel line
  - Fuses
  - Bulbs
  - Battery (after 1 year in service)
4. Paint and/or decal fading, peeling, blistering, chipping or rusting.
5. Surface rust or corrosion on the chassis and/or drivetrain.



### **The Following Activities Will VOID Warranty Coverage:**

- Any operation or use outside of that described in Owner's Manual
- Racing
- Competition
- Rental and/or other commercial use
- Alteration of the odometer reading
- Towing

### **Dealer's Warranty Responsibilities:**

- Thoroughly check and road test new units before delivery.
- Complete and send Warranty Registration and Card of Delivery to Ural Motorcycles within 3 business days of the sale of motorcycle.
- Accept all eligible motorcycles for warranty service regardless of selling dealer.
- Keep records of all warranty work.
- Attend service schools and annual dealer meetings as provided by Ural Motorcycles.
- Submit warranty claims to Ural Motorcycles within 10 business days of the repair date.
- Send failed parts and/or parts assemblies for an inspection to Ural Motorcycles within 3 (three) business days upon Ural Motorcycle's request at Ural Motorcycles shipping expense.
- Provide digital pictures of failed and/or defective parts and assemblies with all claims.

### **Owner's Warranty Responsibilities:**

- As the owner of Ural motorcycle, you are responsible for the performance of the required maintenance listed in your owner's manual. URAL recommends that you retain all receipts covering maintenance on your motorcycle, but URAL cannot deny warranty solely for the lack of receipts or for your failure to ensure the performance of all scheduled maintenance.
- You are responsible for presenting your motorcycle to an URAL dealer as soon as a problem exists. The warranty repairs should be completed in a reasonable amount of time not to exceed 30 (thirty) days.
- As the motorcycle owner, you should also be aware that URAL may deny you warranty coverage if your motorcycle or a part has failed due to abuse, neglect, improper maintenance or unapproved modifications.

## **LIMITED WARRANTY ON EMISSION CONTROL SYSTEM**

Ural Motorcycles, 14700 NE 95th St. Suite 102, Redmond, WA 98052, USA (hereinafter URAL) warrants that each new 2004 and later Ural motorcycle that includes as standard equipment a headlight, taillight and stoplight, and is street legal:

A. is designed, built and equipped so as to conform at the time of initial retail purchase with all applicable regulations of the United States Environmental Protection Agency, and the California Air Resources Board; and  
B. is free from defects in material and workmanship which cause such motorcycle to fail to conform with applicable regulations of the United States Environmental Protection Agency or the California Air Resources Board for a period of use, depending on the engine displacement: of 30,000 kilometers (18,641 miles), if the motorcycle's engine displacement is 280 cubic centimeters or greater or 5 (five) years from the date of initial retail delivery, whichever first occurs.

### **I. COVERAGE**

Warranty defects shall be remedied during customary business hours at any authorized URAL motorcycle dealer located within the United States of America in compliance with the Clean Air Act and applicable regulations of the United States Environmental Protection Agency and the California Air Resources Board. Any part or parts replaced under this warranty shall become the property of URAL. In the State of California only, emission related warranted parts are specifically defined by the state's Emission Warranty Parts List.

#### **These warranted parts are:**

- Injectors
- Electronic valves
- Air box
- Air cleaner element
- Spark plug
- Ignition coil
- Ignition control valve module
- Catalyst
- Carbon absorber

In the State of California only, Emission Control System emergency repairs, as provided for in the California Administrative Code, may be performed by other than an authorized URAL dealer. An emergency situation occurs when an authorized URAL dealer is not reasonably available, a part is not available within 30 (thirty) days, or a repair is not complete within 30 days. Any replacement part can be used in an emergency repair. URAL will reimburse the owner for the expenses, including diagnosis, not to exceed URAL's suggested retail price for all warranted parts replaced and labor charges based on URAL's recommended time allowance for the warranty repair and the geographically appropriate hourly labor rate. The owner may be required to keep receipts and failed parts in order to receive compensation.

### **II. LIMITATIONS**

This Emission Control System warranty shall not cover any of the following:

A. Repair or replacement required as a result of

- (1) Accident
- (2) Misuse
- (3) Repairs improperly performed or replacements improperly installed
- (4) Use of replacement parts or accessories not conforming to URAL specifications which adversely affect performance and/or
- (5) Use in competitive racing or related events.

A. Inspections, replacement of parts and other services and adjustments required for required maintenance

B. Any motorcycle on which the odometer mileage has been changed so that actual mileage cannot be readily determined.

### **III. LIMITED LIABILITY**

A. The liability of URAL under this Emission Control System Warranty is limited solely to the remedying of defects in material or workmanship by authorized URAL motorcycle dealers at its place of business during customary business hours. This warranty does not cover inconvenience or loss of use of the motorcycle or transportation of the motorcycle to or from the URAL dealer. URAL SHALL NOT BE LIABLE FOR ANY OTHER EXPENSES, LOSS OR DAMAGE, WHETHER DIRECT, INCIDENTAL, CONSEQUENTIAL OR EXEMPLARY ARISING IN CONNECTION WITH THE SALE OR USE OF OR INABILITY TO USE THE URAL MOTORCYCLE FOR ANY PURPOSE. SOME STATES DO NOT ALLOW THE EXCLUSION OR LIMITATION OF ANY INCIDENTAL OR CONSEQUENTIAL DAMAGES, SO THE ABOVE LIMITATIONS MAY NOT APPLY TO YOU.

B. NO EXPRESS EMISSION CONTROL SYSTEM WARRANTY IS GIVEN BY URAL EXCEPT AS SPECIFICALLY SET FORTH HEREIN. ANY EMISSION CONTROL SYSTEM WARRANTY IMPLIED BY LAW, INCLUDING ANY WARRANTY OF MERCHANTABILITY OR FITNESS FOR A PARTICULAR PURPOSE, IS LIMITED TO THE EXPRESS EMISSION CONTROL SYSTEM WARRANTY TERMS STATED IN THIS WARRANTY. THE FOREGOING STATEMENT OF WARRANTY ARE EXCLUSIVE AND IN LIEU OF ALL OTHER REMEDIES. SOME STATES DO NOT ALLOW LIMITATIONS ON HOW LONG AN IMPLIED WARRANTY LASTS SO THE ABOVE LIMITATIONS MAY NOT APPLY TO YOU.

C. No dealer is authorized to modify this URAL Limited Emission Control System Warranty.

### **IV. LEGAL RIGHTS**

THIS WARRANTY GIVES YOU SPECIFIC LEGAL RIGHTS, AND YOU MAY ALSO HAVE OTHER RIGHTS, WHICH VARY FROM STATE TO STATE.

### **V. THIS WARRANTY IS IN ADDITION TO THE URAL LIMITED MOTORCYCLE WARRANTY.**

### **VI. ADDITIONAL INFORMATION**

Any replacement part that is equivalent in performance and durability may be used in the performance of any maintenance or repairs. However, URAL is not liable for these parts. The owner is responsible for the performance of all required maintenance. Such maintenance may be performed at a service establishment or by any individual. The warranty period begins on the date the motorcycle is delivered to an ultimate purchaser.

## **CALIFORNIA EMISSION CONTROL SYSTEM WARRANTY STATEMENT**

### **Your Warranty Rights and Obligations**

The California Air Resources Board and Ural Motorcycles (hereinafter URAL) are pleased to explain the Emission Control System Warranty on your 2005 and later motorcycle. In California, new motor vehicles must be designed, built and equipped to meet the State's stringent anti-smog standards. URAL must warrant the emission control system on your motorcycle for the periods of time listed below provided there has been no abuse, neglect or improper maintenance of your motorcycle. Your emission control system may include parts such as the carburetor, the ignition system, catalytic converter, and engine computer. Also included may be hoses, belts, connectors and other emission-related assemblies. Where a warrantable condition exists, URAL will repair your motorcycle at no cost to you including diagnosis, parts and labor.

### **Manufacturer's Warranty Coverage**

Class III motorcycles (280cc and larger): for a period of use of five (5) years or 30,000 kilometers (18,641 miles), whichever first occurs. If an emission-related part on your motorcycle is defective, the part will be repaired or replaced by URAL. This is your emission control system DEFECTS WARRANTY.

### **Owner's Warranty Responsibilities**

- As the owner of Ural motorcycle, you are responsible for the performance of the required maintenance listed in your owner's manual. URAL recommends that you retain all receipts covering maintenance on your motorcycle, but URAL cannot deny warranty solely for the lack of receipts or for your failure to ensure the performance of all scheduled maintenance.
- You are responsible for presenting your motorcycle to an URAL dealer as soon as a problem exists. The warranty repairs should be completed in a reasonable amount of time not to exceed 30 (thirty) days.
- As the motorcycle owner, you should also be aware that URAL may deny you warranty coverage if your motorcycle or a part has failed due to abuse, neglect, improper maintenance or unapproved modifications.

If you have any questions regarding your warranty rights and responsibilities, you should contact Ural Motorcycles at 1-425-702-8484 or the California Air Resource Board at 9528 Telstar Avenue, El Monte, CA 91731.

## **EXTENDED WARRANTY**

### **To Qualify For The Ural Extended Warranty:**

- The URAL Extended Warranty must be purchased from a Dealer within the United States who is authorized by IMWA, Inc. to sell motorcycles.
- The customer may purchase the Ural Extended Warranty, at any time, prior to the expiration of the initial factory two (2) year warranty.

### **Warranty Time Period**

- Duration: One (1) years parts and labor.
- Coverage begins the date after our standard two (2) year warranty ends.

### **Warranty Coverage**

- The Ural extended warranty will follow the same terms and conditions of the current existing Manufactures Warranty.
- There is no mileage limitation.

## **SPARE PARTS AND ACCESSORIES WARRANTY**

Ural Motorcycles provides limited warranty for spare parts and accessories for the following period of time starting from the time of purchase of the parts by a dealer or retail customer:

- Engine – 12 months
- Gearbox – 12 months
- Final drive – 12 months
- Alternator – 6 months
- Starter – 6 months
- EFI Components – 6 months
- All other parts and accessories - 30 days

The above applies ONLY in cases when a dealer or retail customer identifies defects before using parts and/or accessories or these defects are identified during use AND provided these parts and/or accessories have been properly installed by Ural Motorcycles or an authorized Ural dealer.

Irbit Motorworks of America, Inc.  
14700 Ne 95<sup>th</sup> St. Suite 102  
Redmond, WA 98052

### **REPORTING SAFETY DEFECTS**

If you believe that your vehicle has a defect which could cause a crash or could cause injury or death, you should immediately inform the National Highway Traffic Safety Administration (NHTSA) in addition to notifying Irbit Motorworks of America, Inc.

If NHTSA receives similar complaints, it may open an investigation, and if it finds that a safety defect exists in a group of vehicles, it may order a recall and remedy campaign. However, NHTSA cannot become involved in any individual problems between you, your dealer, or Irbit Motorworks of America, Inc.

To contact NHTSA you may either call the Auto Safety Hotline toll-free at:

1-800-424-9393 (366-0123 in Washington, DC area).

Or write to:

NHTSA  
U.S. DEPARTMENT of TRANSPORTATION  
400 7th Street SW, (NSA-11)  
Washington, DC 20590

You can also obtain other information about motor vehicle safety from the Hotline.

## 9. Emission Control Information

|                                     | Page |
|-------------------------------------|------|
| Crankcase Emission Diagram          | 9-2  |
| California Emission Control Diagram | 9-3  |
| Vehicle Emission Control Label      | 9-4  |

## CRANKCASE EMISSION DIAGRAM

### CLOSED CRANKCASE:

No crankcase emissions will be discharged directly into the ambient atmosphere throughout the useful life by any vehicle to be covered by EPA Certification.

Crankcase exhaust emitted by the timed breather is routed to the air filter box and ends prior to the filter. The crankcase exhaust is recycled through the air filter and inducted back into the engine.

Please see the diagram below:

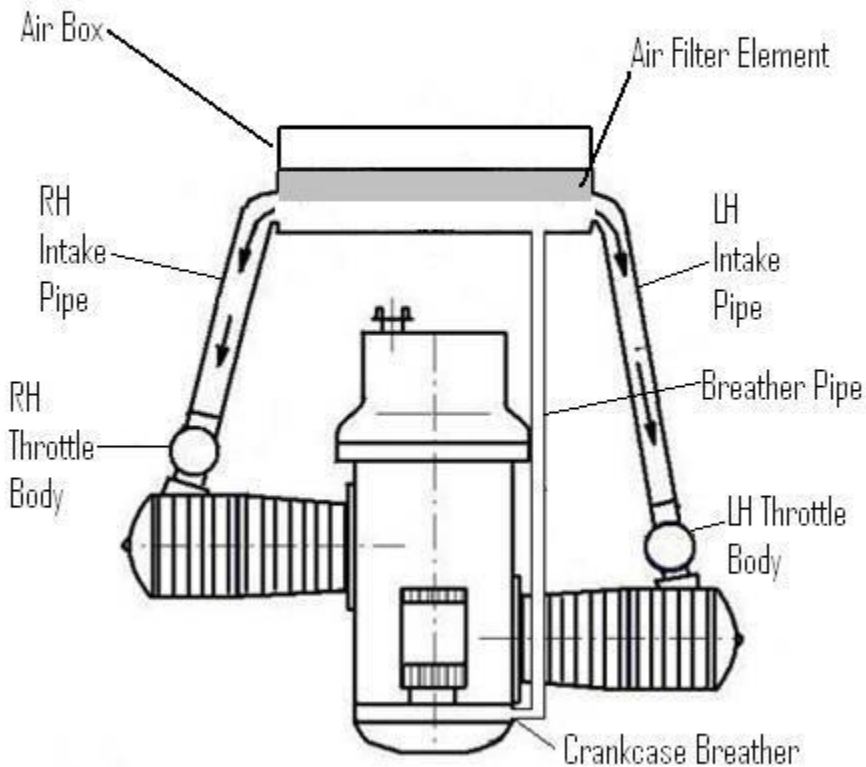

**NOTE**

**IT IS AGAINST FEDERAL LAW TO TAMPER WITH OR REMOVE EMISSION RELATED COMPONENTS.**



## CALIFORNIA EMISSION CONTROL DIAGRAM

### EVAPORATIVE EMISSION CONTROL:

All models sold and shipped into the state of California are equipped with an evaporative emission control system. This system prevents fuel vapors from being discharged directly into the ambient atmosphere throughout the useful life.

Evaporative emission are routed from the fuel tank through a carbon canister to the air box and controlled by an electrical valve. The evaporative emissions are recycled through the air filter and inducted back into the engine.

Please see the diagram below:

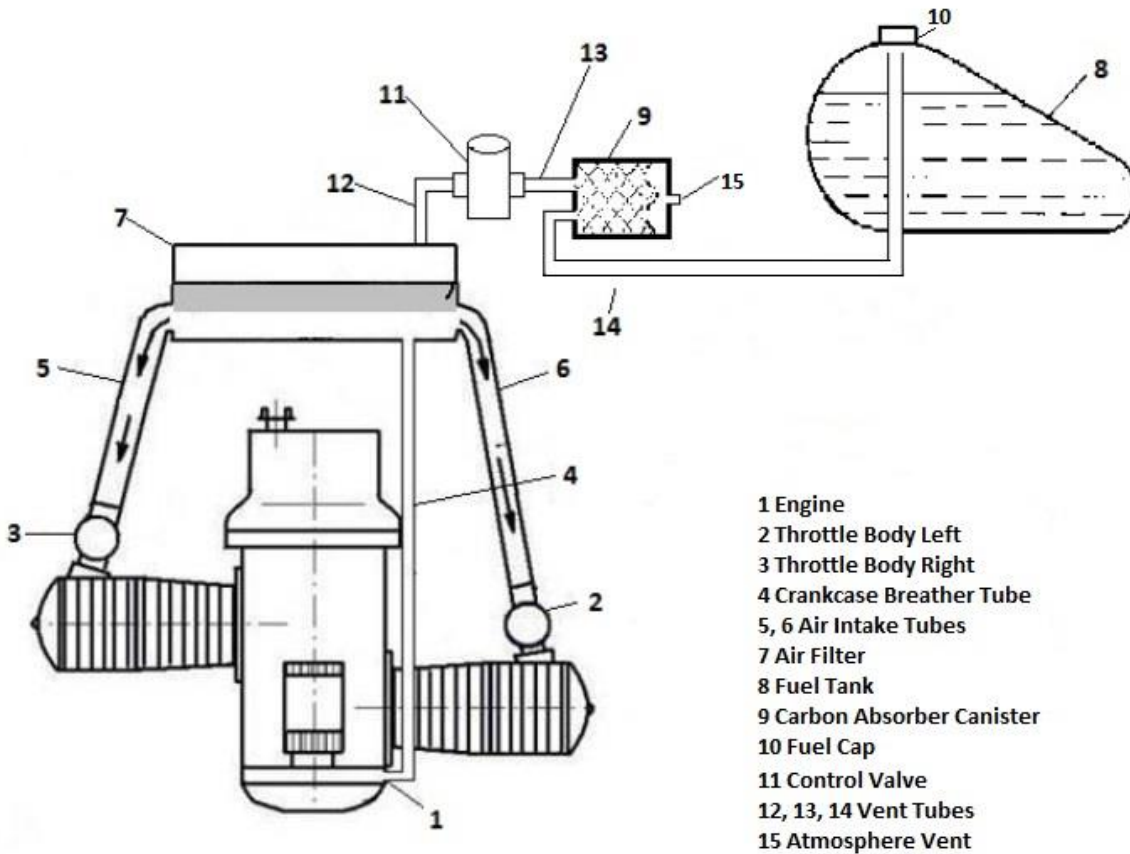

#### NOTE

IT IS AGAINST FEDERAL LAW TO TAMPER WITH OR REMOVE EMISSION RELATED COMPONENTS.

## VEHICLE EMISSION CONTROL LABEL

The emission control label is located on the left hand frame down tube on all motorcycles.

Please see the sample diagram below:

|  |   |
|--|---|
|   | <b>VEHICLE EMISSION CONTROL INFORMATION</b><br>Engine tune-up specification for: <b>IMZ-Kazakhstan, LLC</b> |
| <b>"IMZ" Engine Displacement 749cc: PIMFC0750Z03; PIMFPMETALU1 (Please Read Owner's Manual for Details)</b>                        |   |
| <b>Idle Speed: 900 RPM (at normal temp)</b>  | <b>Max RPM: 6,200</b>   |
| <b>Ignition Timing: Factory Preset</b>   | <b>Idle Mixture: Factory Preset</b>   |
| <b>Plug type: NGK BPR7HS-10</b>  | <b>Lubricant: SAE 20W50</b>   |
| <b>Plug Gap: 0.040 (1.0-1.02mm)</b>  | <b>Fuel: 91 octane</b>  |
| <b>Valve Clearance (cold): 0.05-0.10mm (.002-.004 in)(exhaust and intake) Exhaust Emission Control System: TWC, HO2S, TBI, ECU</b> |   |
| <b>This vehicle conforms to all US EPA and California regulations applicable to 2023 Model Year New Motorcycles</b>                |   |

## 10. Owner's Documents

New Owner Form  
New Address Form  
Training Rebate Form

Intentionally left blank



Intentionally left blank



**NEW ADDRESS FORM**

If you move, please fill out the form and mail to the address below. This will insure that you continue to receive all correspondence from Irbit Motorworks of America.

VEHICLE IDENTIFICATION NUMBER

\_\_\_\_\_

OWNER'S NAME \_\_\_\_\_

OLD ADDRESS \_\_\_\_\_ APT. NO. \_\_\_\_\_

CITY \_\_\_\_\_ STATE \_\_\_\_\_ ZIP CODE \_\_\_\_\_

MY NEW ADDRESS IS:

NEW ADDRESS \_\_\_\_\_ APT. NO. \_\_\_\_\_

CITY \_\_\_\_\_ STATE \_\_\_\_\_ ZIP CODE \_\_\_\_\_

**Mail this form to:**

**Irbit Motorworks of America, Inc.**  
14700 NE 95<sup>th</sup> St., Suite 102  
Redmond, WA 98052

**Or fax to: (425) 250-6762**

**\*\*We never sell or rent your personal information to third parties unaffiliated with Ural.**

Intentionally left blank





## URAL SIDECAR SAFETY TRAINING REBATE FORM

URAL is offering a mail-in rebate in the amount of **up to \$125** to any customer who takes a sidecar safety-training course within one year from the date of purchase of a new Ural sidecar motorcycle.

The most up to date list of safety training courses in US can be found on the Evergreen Safety Council website: <http://www.esc.org> or by calling: **1-800-521-0778**

### MAIL IN:

Please detach and return (1) this completed rebate form, along with (2) a copy of Sidecar Safety-training course payment receipt and (3) certificate of course completion to:

URAL Sidecar Safety Training Rebate  
14700 NE 95th Street, Suite 102  
Redmond, WA 98052

Full Name (First, Last): \_\_\_\_\_

Street Address: \_\_\_\_\_

City, State & ZIP: \_\_\_\_\_

Daytime Phone: \_\_\_\_\_ E-mail: \_\_\_\_\_

Your Ural VIN# \_\_\_\_\_

Bike Purchase Date: \_\_\_\_\_

### SUBMIT ONLINE:

GO TO: [www.imz-ural.com/sidecar-safety-training](http://www.imz-ural.com/sidecar-safety-training)

**Thank You and Ride Safe!**

Offer Valid with purchase of a new Ural motorcycle. Your rebate will be mailed to you within 6-8 weeks of receipt and verification. IMWA is not responsible for lost or misdirected mail. Only Sidecar Safety Training is qualified for rebate. Training must take place within 12 months of purchase of a new sidecar model Ural. Rebate not to exceed cost of the actual course or \$125; whichever is less.

Offer good only in the U.S. and void where prohibited, restricted or taxed by law.

© 2017 Irbit MotorWorks of America, Inc.

Intentionally left blank

# 11. Schematics

Wiring Diagram



# 2019 URAL Motorcycle Wire Harness

## SIDECAR

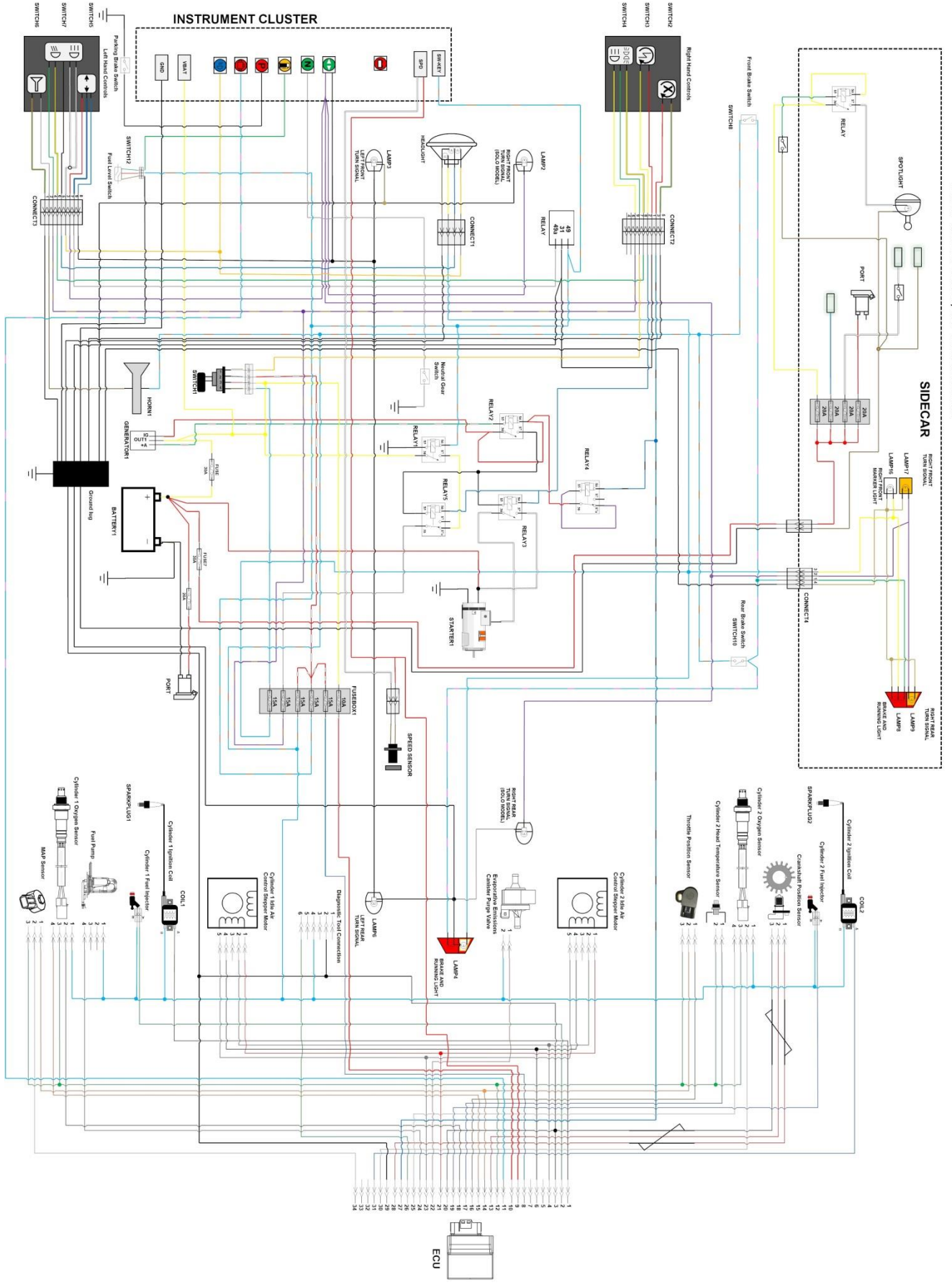

SPOTLIGHT

RIGHT FRONT TURN SIGNAL

RIGHT REAR LAMP

RIGHT REAR TURN SIGNAL

LAMP5  
BRAKE AND TURN SIGNAL

LAMP4  
BRAKE AND TURN SIGNAL

LAMP3  
BRAKE AND TURN SIGNAL

LAMP2  
BRAKE AND TURN SIGNAL

LAMP1  
BRAKE AND TURN SIGNAL

Front Brake Switch

SWITCH

SWITCH

SWITCH

CONNECT

CONNECT

CONNECT

CONNECT

CONNECT

CONNECT

Right Head Controls

SWITCH

SWITCH

SWITCH

CONNECT

CONNECT

CONNECT

CONNECT

CONNECT

CONNECT

CONNECT

CONNECT

LAMP2

RELAY

CONNECT

RELAY

RELAY

RELAY

RELAY

RELAY

RELAY

RELAY

RELAY

RELAY

RELAY

RELAY

HEADLIGHT

LAMP5

LAMP4

LAMP3

LAMP2

LAMP1

RELAY

RELAY

RELAY

RELAY

RELAY

RELAY

RELAY

RELAY

RELAY

SWITCH

SWITCH

SWITCH

SWITCH

SWITCH

SWITCH

SWITCH

SWITCH

SWITCH

SWITCH

SWITCH

SWITCH

SWITCH

SWITCH

SWITCH

SWITCH

SWITCH

SWITCH

SWITCH

SWITCH

SWITCH

SWITCH

SWITCH

SWITCH

SWITCH

SWITCH

SWITCH

SWITCH

SWITCH

SWITCH

SWITCH

SWITCH

SWITCH

SWITCH

SWITCH

SWITCH

SWITCH

SWITCH

SWITCH

SWITCH

SWITCH

SWITCH

SWITCH

SWITCH

SWITCH

SWITCH

SWITCH

SWITCH

SWITCH

SWITCH

SWITCH

SWITCH

SWITCH

SWITCH

SWITCH

SWITCH

SWITCH

SWITCH

SWITCH

SWITCH

SWITCH

SWITCH

SWITCH

SWITCH

SWITCH

SWITCH

SWITCH

SWITCH

SWITCH

SWITCH

SWITCH

SWITCH

SWITCH

SWITCH

SWITCH

SWITCH

SWITCH

SWITCH

SWITCH

SWITCH

SWITCH

SWITCH

SWITCH

SWITCH

SWITCH

SWITCH

SWITCH

SWITCH

SWITCH

SWITCH

SWITCH

SWITCH

SWITCH

SWITCH

SWITCH

SWITCH

SWITCH

SWITCH

SWITCH

SWITCH

SWITCH

SWITCH

SWITCH

SWITCH

SWITCH

SWITCH

SWITCH

SWITCH

SWITCH

SWITCH

SWITCH

SWITCH

SWITCH

SWITCH

SWITCH

SWITCH

SWITCH

SWITCH

SWITCH

SWITCH

SWITCH

SWITCH

SWITCH

SWITCH

SWITCH

SWITCH

SWITCH

SWITCH

SWITCH

SWITCH

SWITCH

SWITCH

SWITCH

SWITCH

SWITCH

SWITCH

SWITCH

SWITCH

SWITCH

SWITCH

SWITCH

SWITCH

SWITCH

SWITCH

SWITCH

SWITCH

SWITCH

SWITCH

SWITCH

SWITCH

SWITCH

SWITCH

SWITCH

SWITCH

SWITCH

SWITCH

SWITCH

SWITCH

SWITCH

SWITCH

SWITCH

SWITCH

SWITCH

SWITCH

SWITCH

SWITCH

SWITCH

SWITCH

SWITCH

SWITCH

SWITCH

SWITCH

SWITCH

SWITCH

SWITCH

SWITCH

SWITCH

SWITCH

SWITCH

SWITCH

SWITCH

SWITCH

SWITCH

SWITCH

SWITCH

SWITCH

SWITCH

SWITCH

SWITCH

SWITCH

SWITCH

SWITCH

SWITCH

SWITCH

SWITCH

SWITCH

SWITCH

SWITCH

SWITCH

SWITCH

SWITCH

SWITCH

SWITCH

SWITCH

SWITCH

SWITCH

SWITCH

SWITCH

SWITCH

SWITCH

SWITCH

SWITCH

SWITCH

SWITCH

SWITCH

SWITCH

SWITCH

SWITCH

SWITCH

SWITCH

SWITCH

SWITCH

SWITCH

SWITCH

SWITCH

SWITCH

SWITCH

SWITCH

SWITCH

SWITCH

SWITCH

SWITCH

SWITCH

SWITCH

SWITCH

SWITCH

SWITCH

SWITCH

SWITCH

SWITCH

SWITCH

SWITCH

SWITCH

SWITCH

SWITCH

SWITCH

SWITCH

SWITCH

SWITCH

SWITCH

SWITCH

SWITCH

SWITCH

SWITCH

SWITCH

SWITCH

SWITCH

SWITCH

SWITCH

SWITCH

SWITCH

SWITCH

SWITCH

SWITCH

SWITCH

SWITCH

SWITCH

SWITCH

SWITCH

SWITCH

SWITCH

SWITCH

SWITCH

SWITCH

SWITCH

SWITCH

SWITCH

SWITCH

SWITCH

SWITCH

SWITCH

SWITCH



URAL MOTORCYCLES  
14700 NE 95TH ST.  
SUITE 102  
REDMOND, WA 98052

[IMZ-URAL.COM](http://IMZ-URAL.COM)